

# Open continuous current (DC) motors LSK

## General information

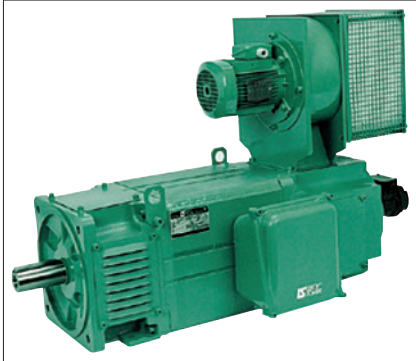

**LSK open continuous current (dc) motors**

- frame size 112 to 355 mm,
- power 2 to 750 kW.

### Conditions of use

According to the standard IEC 34-1, the standard motors can operate in the following standard conditions:

- ambient temperature within the range +5 and +40°C,
- altitude less than 1 000 m,
- atmospheric pressure: 1 050 mbar,
- absolute humidity taking values between 5 and 23 g/m<sup>3</sup>,
- ambient air chemically neutral and dust-free,
- current range from 50 to 100 % of  $I_N$  in continuous operation and higher in transient operation.

• **Under load: if the motor must be permanently used in under load (less than 50 % of the rated current) one must absolutely consult LEROY-SOMER for adaptation.**

N.B.: refer to the technical catalogue to check axial or radial loads, overloads abilities, protection system of the motor, IP 55 in particular.



Component	Materials	Remarks
Stator (or casing)	Insulated low carbon magnetic steel laminations Enameled cathode copper, class H	- the low carbon content guarantees long term stability of the characteristics - prestressed sheet steel laminations welded using MIG process - main poles built into the entire range (except for LSK 1324C and 1604C) - auxiliary poles built in up to LSK 1604, mentioned further on - insulation system class H
Armature	Insulated low carbon magnetic steel laminations Enameled electrolytic copper, class H	- the low carbon content guarantees long term stability of the characteristics - semi-enclosed inclined slots - binding reinforced with heat-treated polymerised fibreglass - cooling ducts - insulation system class H
Commutator	Silver-plated copper on resin	- toothed type - large number of blades - ventilated by ducts
Shaft	Steel	- open key - round-ended key
Brush holder Brushes	Thermoset resin and bronze Electrographitic compound	- moulded, rigid, it can be rotated - adjustment position marked in relation to neutral axis - evenly-spaced accurate brush holders - detection of wear limit on brush holders (optional) - brush with dampers
End shields	FGL cast iron	- front flange integrated into endshield (machined on request for LSK 1124 to 1804) - feet intergrated into front and rear endshields - inspection doors on front flange: 3 on LSK 1124 to 1604, 4 on larger models - 4 inspection doors on rear shield - square inspection doors, all with identical mounting to allow accessories to be fixed at 90° (LSK 1124 to 1324)
Bearings and lubrication	Steel	- ball bearings, series 6300 (wide), set C3, high load capacity - 2RS type, sealed, greased for life up to LSK 2004, open with a greasing system thereafter - front preloaded on the bearing - horizontal movement of rear bearing blocked
Fan	Steel sheet metal	- multivoltage, multifrequency, 2 poles, IP 55 fan motor - multiposition fan, independent of the position of the terminal box - axial fan cooling kit
Terminal box	Aluminium alloy Cast iron Steel	- multiposition - removable cable gland support plate - can be located at the rear (LSK 1124 to 1604) - IP 55 (sealed) - 6 terminals + connector for options

### Armature voltage according to power supplies

Single phase sector	Maximum armature voltage	Three-phase sector	Maximum armature voltage
V	V	V	V
220 - 230	180 - 190	220	250
380 - 400	310 - 320	230	260
415	340	240	270
		380	440
		400	460
		415	470
		440	500
		500	570
		660	600

### Excitation voltage<sup>1</sup> according to power supplies

Single phase sector	Excitation voltage
V	V
230	210
400	360
«Parallel series» connection	
Rated voltage	can be used from
180 - 360	160 to 190 or 320 to 380

1. Excitation for a full wave rectified current supply.

# Open continuous current (DC) motors LSK

## Mounting positions

### Foot mounted motors

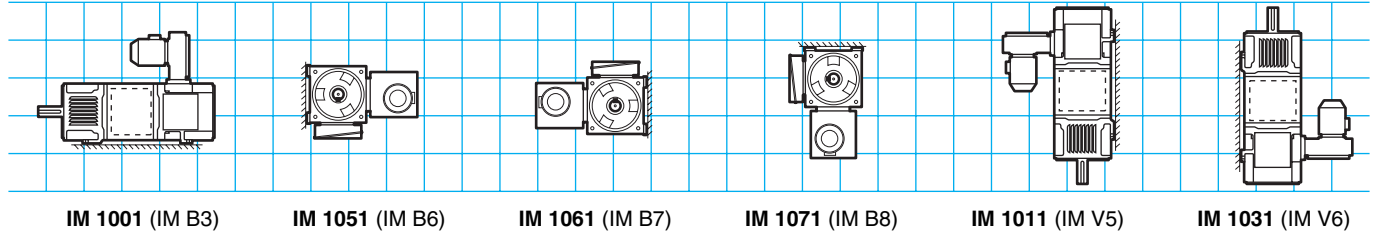

### (FF) plain holes flange mounted motors

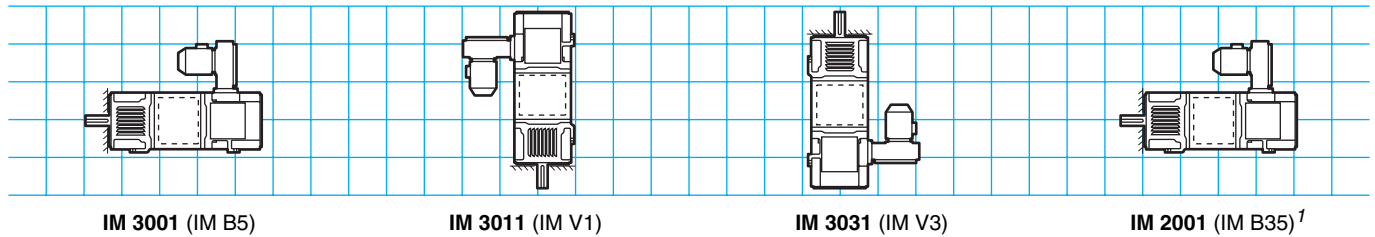

### Positions of the terminals box (TB) and of the forced ventilation (VF)

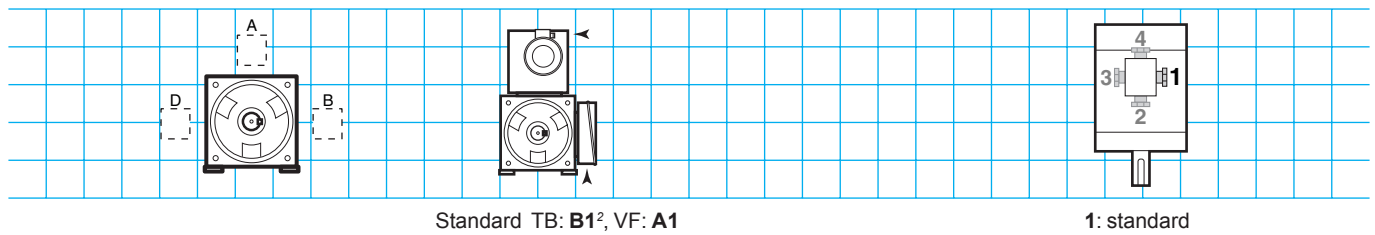

### Possible configurations

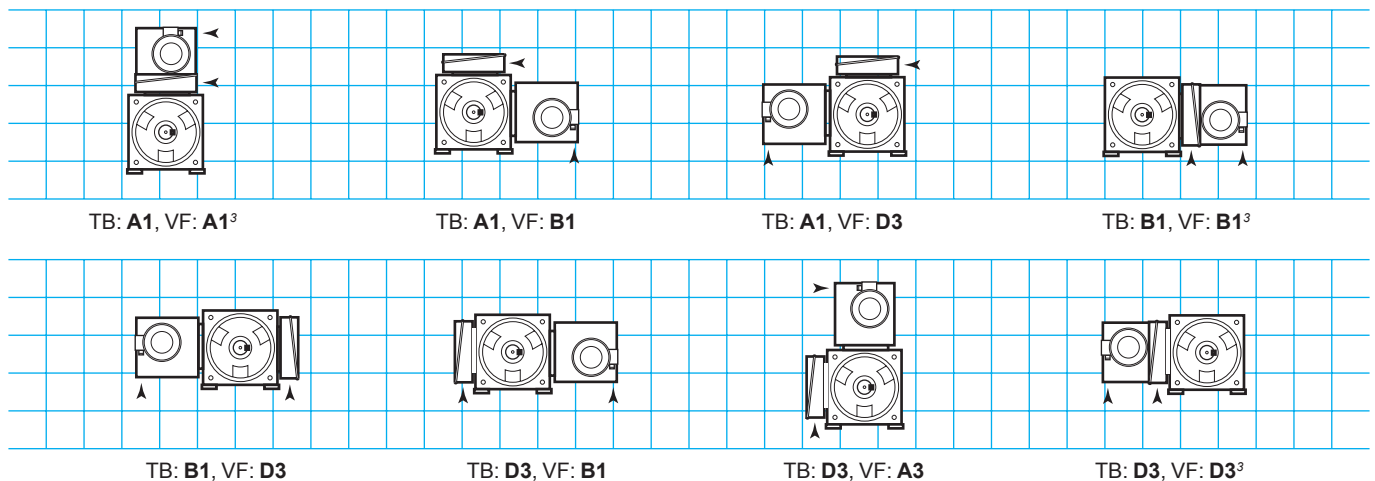

1. Flange and foot position. 2. The arrow indicates the cables entry. 3. Cable gland mounting plate in position 2 for sizes 1124 and 1324.

### Mounting possibilities according to the frame size

Frame size	Mounting positions											
	IM 1001	IM 1051	IM 1061	IM 1071	IM 1011	IM 1031	IM 3001	IM 3011	IM 3031	IM 2001	IM 2011	IM 2031
112 - 132	•	•	•	•	•	•	•	•	•	•	•	•
160	•	•	•	•	•	•	•	•	•	•	•	•
180	•	•	•	•	•	•	•	•	•	•	•	•
200 to 280	•							•		•		
355	•									•		

• : Possible mounting positions. Consult us for all other positions.

# Open continuous current (DC) motors LSK

## Adaptation possibilities

☞ **LSK motors may be associated to:**

• **gearboxes with universal mounting:**

- Cb with coaxial or parallel axles,
- Ot with conical gear,
- Pl with planetary gear.

• **electronic variable speed drive:**

- 2 and 4 quadrants.

☞ **The options:**

- roller bearings
- second shaft end
- plain hole flange adapter
- brush wear limit detector and pressure splitter incorporated
- air filter
- air flow detector
- safety brake:
  - for normal use: 32 to 400 N.m (sizes 1124 to 1604),
  - for intensive use: consult us.
- speed detection:
  - tachometric dynamo, normal or reinforced, 60 V / 1 000 min<sup>-1</sup>,
  - pulse generator (or encoder), 11 to 30 V.

Leroy-Somer offers various options and adaptation possibilities for its motors. They are described below and offered in this catalogue, in the section relating to gearboxes, or in the chapter on speed variation for the types of motorised variable speed drives selected.

For the applications that are not specified in the selection tables, consult the technical specialists at Leroy-Somer.

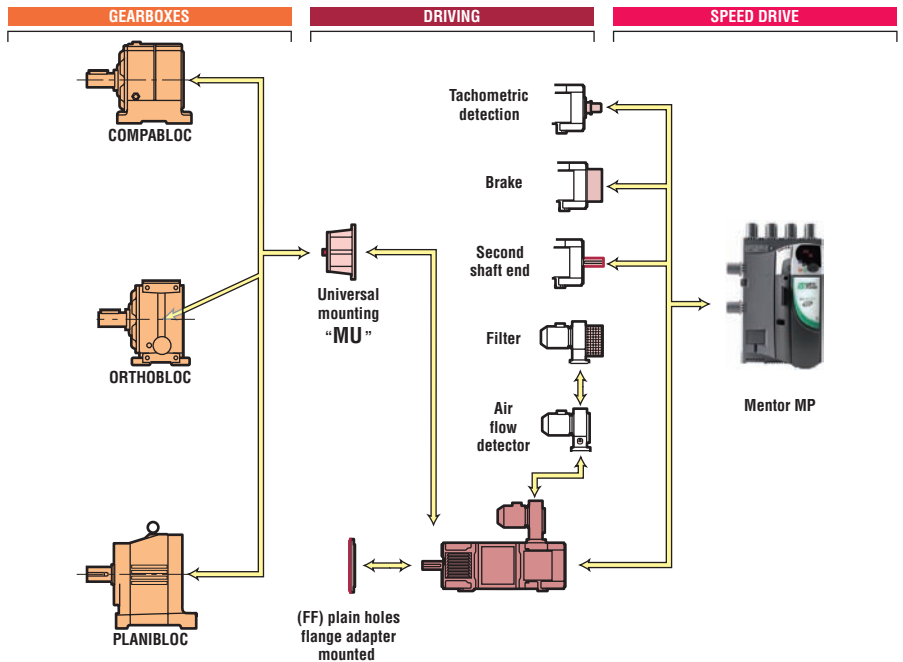

## Designation / Codification

<b>LSK</b>	<b>1604</b>	<b>L 10</b>	<b>460 V</b>	<b>2330 min<sup>-1</sup></b>	<b>113 kW</b>	<b>IM 1001</b>	<b>180 V</b>	<b>IC 06</b>	<b>IP 23S</b>
Motor type	Frame size Polarity	Stator designation Builder index	Armature voltage	Rated speed	Rated power	Construction form	Excitation voltage	Cooling index	Protection index

☞ **Codification example:**

Motor 113 kW, 2330 min<sup>-1</sup>, IM 1001, 460/180 V

**Designation**

- LSK 1604 L10 113 kW

**Code**

-

All the products in this catalogue have a code.

The coding table is incorporated in the price list together with the list of designations.

Each electromechanical product is classified first in order of power and then in order of speed.

# Open continuous current (DC) motors LSK

## Preselection chart

### Selection example:

#### Data:

- 48 kW at 2500 min<sup>-1</sup>
- variable speed drive output voltage 440 V
- operation constant power up to 3800 min<sup>-1</sup>

#### Operating mode:

- Preselect the motor size using the chart opposite: LSK 1324.
- In the selection table look for the power closest to 48 kW in the 440 V armature voltage column: P = 49 kW at 2530 min<sup>-1</sup>

How can the rated speed be adjusted to the required speed ?

- by adjusting the armature voltage (output of the variable speed drive), by up to + 5 %, the power is corrected proportionally;
- or by adjusting the excitation: by reducing this, the speed is increased at constant power.

In this situation, in order to be used at 3200 min<sup>-1</sup>, the motor will be supplied at:

$$440 \times \frac{2500}{2530} = 435 \text{ V}$$

$$\text{and } P = 49 \times \frac{435}{440}, \text{ or } 48.4 \text{ kW.}$$

The variation in armature voltage is 1.15 %, thus lower than the limit. In order to achieve the operation in overload at constant power, select the compensated version (for the non compensated version, the limit is 3500 min<sup>-1</sup>).

See the extract from the selection table below.

#### Selected motor:

LSK 1324 VL 11 - 440 V - 49 kW...  
IC 06

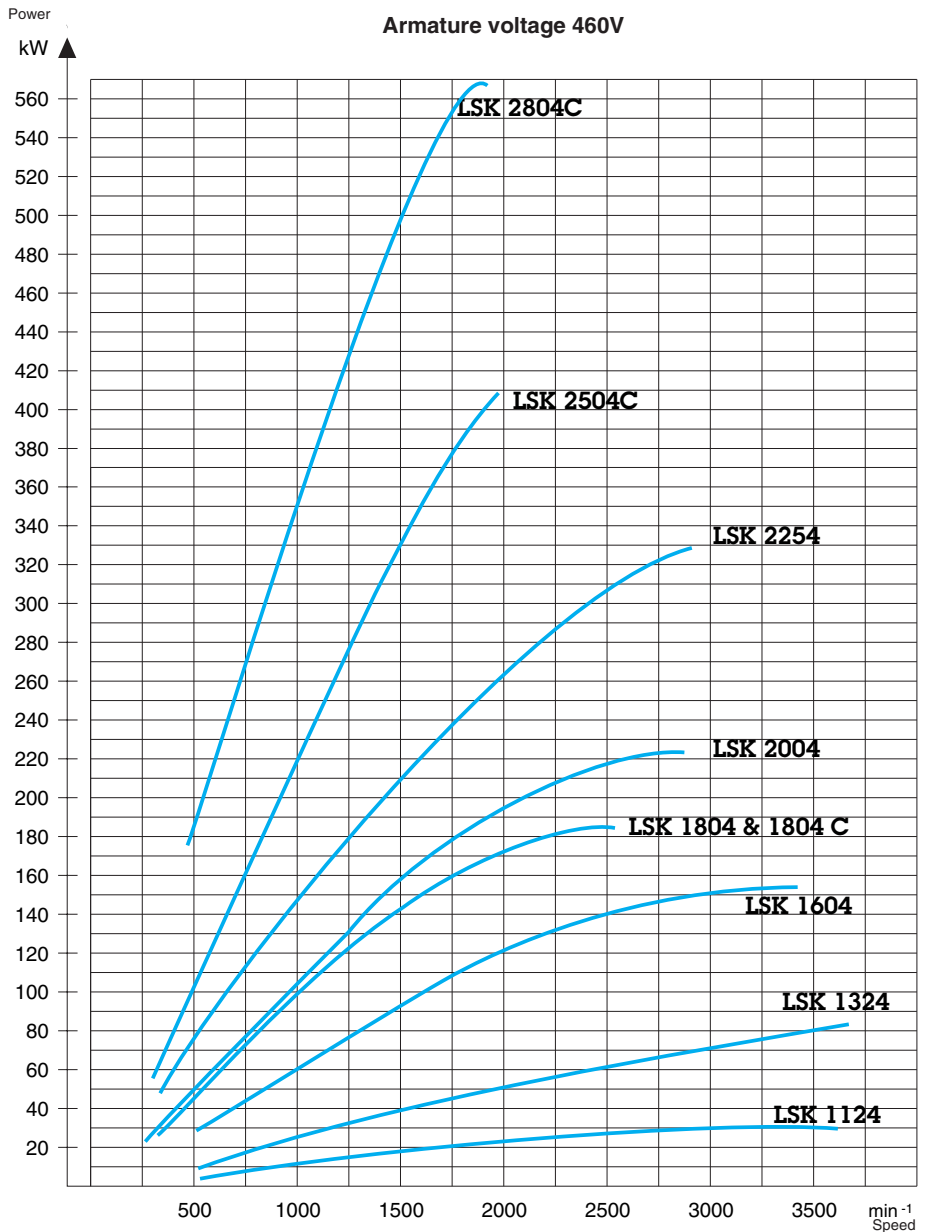

P	Rotation speed n for armature voltage U						n <sub>maxi</sub> elec.		M	I	Manuf. index
	400 V min <sup>-1</sup>	400 V min <sup>-1</sup>	420 V min <sup>-1</sup>	440 V min <sup>-1</sup>	460 V min <sup>-1</sup>	500 V min <sup>-1</sup>	N.C. min <sup>-1</sup>	C. min <sup>-1</sup>			
28.1	1500						3200	4000	179	127	11
44.7		2300					3400	4000	186	126.5	11
46.6			2420				3500	4000	184	126	11
<b>49</b>				<b>2530</b>			<b>3500</b>	4000	185	126	<b>11</b>
49.5					2640		3500	4000	179	121	11
52.7						2870	3500	4000	175	116	11
61.4								4000	170	111.5	C 11

# Open continuous current (DC) motors LSK 1124 M

## Selection

**IP 23S motor - IC 06 ventilation - Class H**  
**Full bridge three-phase power supply**  
**S1 duty - Ambient temperature  $\leq 40^{\circ}\text{C}$  - Total weight: 101 kg - Inertia moment: 0,053 kg.m<sup>2</sup>**  
**Excitation power: 0.65 kW - Maximum mechanical speed: 4000 min<sup>-1</sup>**

P	Rotation speed $n$ for armature voltage $U$							$n_{max}$	M	I	$\eta$	L	$R_{115^{\circ}}$	$U_{max}$	Index	Qty
	220 V min <sup>-1</sup>	260 V min <sup>-1</sup>	400 V min <sup>-1</sup>	420 V min <sup>-1</sup>	440 V min <sup>-1</sup>	460 V min <sup>-1</sup>	500 V min <sup>-1</sup>									
3.5	570							1120	59	24	0.67	41	3.76	500	03	
4.4		670						1320	63	24	0.71	41	3.76	500		
7.1			1070					1650	63	23.5	0.76	41	3.76	500		
7.6				1120				1730	65	23.5	0.77	41	3.76	500		
8					1170			1810	65	23.5	0.78	41	3.76	500		
8.5						1230		1900	66	23.5	0.79	41	3.76	500		
9.2							1330	2060	66	23	0.80	41	3.76	500		
4.7	730							1440	61	30	0.71	25	2.54	500	04	1
5.9		860						1710	66	29.5	0.77	25	2.54	500		
9			1370					2120	63	29	0.78	25	2.54	500		
9.5				1440				2230	63	28.5	0.79	25	2.54	500		
10					1510			2340	63	28.5	0.80	25	2.54	500		
10.5						1580		2440	63	28.5	0.80	25	2.54	500		
11.6							1710	2650	65	28.5	0.81	25	2.54	500		
6.7	1020							2000	63	40.5	0.77	14	1.39	500	05	1
8.2		1200						2380	65	40	0.79	14	1.39	500		
13			1910					2960	65	39.5	0.82	14	1.39	500		
13.5				2000				3100	64	39	0.83	14	1.39	500		
14.2					2100			3250	65	38.5	0.84	14	1.39	500		
14.9						2200		3410	65	38.5	0.84	14	1.39	500		
16.3							2390	3700	65	38.5	0.85	14	1.39	500		
11	1580							3070	66	60.5	0.83	6.5	0.61	500	06	1
13.1		1860						3600	67	60	0.84	6.5	0.61	500		
20.2			2950					4000	65	59	0.85	6.5	0.61	500		
21.1				3100				4000	65	58.5	0.86	6.5	0.61	500		
22					3250			4000	65	58	0.86	6.5	0.61	500		
23.2						3400		4000	65	58	0.87	6.5	0.61	500		
25.3							3690	4000	65	58	0.87	6.5	0.61	500		

1. Higher speed ranges by field weakening can be studied according to the application : consult us.

P : Rated power  
M : Rated moment  
I : Permissible current in continuous operation  
 $\eta$  : Efficiency  
L : Motor self-induction coil  
R : Armature resistance at 115°C  
 $U_{max}$  : Maximum armature voltage

# Open continuous current (DC) motors LSK 1124 L

## Selection

**IP 23S motor - IC 06 ventilation - Class H**  
**Full bridge three-phase power supply**  
**S1 duty - Ambient temperature  $\leq 40^{\circ}\text{C}$  - Total weight: 126 kg - Inertia moment: 0.066 kg.m<sup>2</sup>**  
**Excitation power: 0.65 kW - Maximum mechanical speed: 4000 min<sup>-1</sup>**

P	Rotation speed $n$ for armature voltage $U$							$n_{max}$	M	I	$\eta$	L	$R_{115^{\circ}}$	$U_{max}$	Index	Qty
	220 V min <sup>-1</sup>	260 V min <sup>-1</sup>	400 V min <sup>-1</sup>	420 V min <sup>-1</sup>	440 V min <sup>-1</sup>	460 V min <sup>-1</sup>	500 V min <sup>-1</sup>									
4	510							1000	75	28	0.66	35	3.26	500	04	
5.1		600						1200	81	28	0.70	35	3.26	500		
8.3			960					1480	83	27.5	0.75	35	3.26	500		
8.8				1010				1560	83	27.5	0.76	35	3.26	500		
9.3					1060			1640	84	27.5	0.77	35	3.26	500		
9.8						1110		1720	84	27.5	0.77	35	3.26	500		
10.7							1200	1860	85	27	0.79	35	3.26	500		
5.9	710							1420	79	36.5	0.74	20	1.79	500	05	
7.2		840						1700	82	36	0.77	20	1.79	500		
11.4			1350					2090	81	35.5	0.80	20	1.79	500		
12				1420				2200	81	35.5	0.81	20	1.79	500		
12.7					1490			2300	81	35.5	0.81	20	1.79	500		
13.4						1560		2410	82	35.5	0.82	20	1.79	500		
14.5							1700	2630	81	35	0.83	20	1.79	500		
9.7	1150							2200	81	55	0.80	9.5	0.787	500	06	
11.6		1350						2640	82	54.5	0.82	9.5	0.787	500		
18.2			2180					3280	80	54	0.84	9.5	0.787	500		
19.3				2290				3440	80	54	0.85	9.5	0.787	500		
20.4					2400			3610	81	54	0.86	9.5	0.787	500		
21.4						2500		3780	82	54	0.86	9.5	0.787	500		
23.3							2720	4000	82	53.5	0.87	9.5	0.787	500		
11.4	1430							2840	76	61	0.85	4.3	0.47	500	21	
13.7		1680						3280	78	60.5	0.87	4.3	0.47	500		
21.4			2730					4000	75	60	0.89	4.3	0.47	500		
22.6				2870				4000	75	60	0.90	4.3	0.47	500		
23.8					3000			4000	76	60	0.90	4.3	0.47	500		
24						3130		4000	73	58	0.90	4.3	0.47	500		
25.3							3400	4000	71	56	0.90	4.3	0.47	500		

1. Higher speed ranges by field weakening can be studied according to the application : consult us.

P : Rated power  
M : Rated moment  
I : Permissible current in continuous operation  
 $\eta$  : Efficiency  
L : Motor self-induction coil  
R : Armature resistance at 115°C  
 $U_{max}$  : Maximum armature voltage

# Open continuous current (DC) motors LSK 1124 VL

## Selection

**IP 23S motor - IC 06 ventilation - Class H**  
**Full bridge three-phase power supply**  
**S1 duty - Ambient temperature  $\leq 40^{\circ}\text{C}$  - Total weight: 152 kg - Inertia moment: 0.085 kg.m<sup>2</sup>**  
**Excitation power: 0.75 kW - Maximum mechanical speed: 4000 min<sup>-1</sup>**

P	Rotation speed $n$ for armature voltage $U$							$n_{max}$	M	I	$\eta$	L	$R_{115^{\circ}}$	$U_{max}$	Index	Qty
	220 V min <sup>-1</sup>	260 V min <sup>-1</sup>	400 V min <sup>-1</sup>	420 V min <sup>-1</sup>	440 V min <sup>-1</sup>	460 V min <sup>-1</sup>	500 V min <sup>-1</sup>									
3.6	370							650	93	27.5	0.63	40	3.64	500	04	
4.9		440						780	106	27	0.70	40	3.64	500		
8.1			720					970	107	26.5	0.76	40	3.64	500		
8.7				760				1020	109	26	0.79	40	3.64	500		
9.2					790			1060	111	26	0.79	40	3.64	500		
9.8						830		1120	113	26	0.81	40	3.64	500		
10.9							900	1210	116	26	0.83	40	3.64	500		
5.7	530							930	103	37	0.74	23	1.93	500		
7.4		630						1120	112	36.5	0.78	23	1.93	500		
11.5			1030					1390	107	34.5	0.83	23	1.93	500		
12.2				1080				1450	108	34	0.85	23	1.93	500		
12.9					1120			1510	110	34	0.86	23	1.93	500		
13.6						1180		1590	110	34	0.86	23	1.93	500		
14.6							1280	1720	111	34	0.87	23	1.93	500		
9.9	840							1410	113	55	0.82	10.2	0.832	500		
12		1000						1680	115	54.5	0.85	10.2	0.832	500		
18.2			1610					2500	108	53	0.86	10.2	0.832	500		
19.2				1700				2550	108	52.5	0.87	10.2	0.832	500		
20.2					1770			2600	109	52	0.88	10.2	0.832	500		
21.3						1850		2600	110	52	0.89	10.2	0.832	500		
23							2000	2600	110	52	0.89	10.2	0.832	500		
10.7	1140							1980	90	58.5	0.83	6.6	0.57	500		
12.6		1350						2360	89	58	0.83	6.6	0.57	500		
20.6			2180					2830	90	57	0.90	6.6	0.57	500		
22				2280				2960	92	57	0.92	6.6	0.57	500		
23					2400			3120	92	57	0.92	6.6	0.57	500		
24.2						2500		3250	92	57	0.92	6.6	0.57	500		
26.3							2710	3520	93	57	0.92	6.6	0.57	500		

1. Higher speed ranges by field weakening can be studied according to the application : consult us.

P : Rated power  
M : Rated moment  
I : Permissible current in continuous operation  
 $\eta$  : Efficiency  
L : Motor self-induction coil  
R : Armature resistance at 115°C  
 $U_{max}$  : Maximum armature voltage

# Open continuous current (DC) motors LSK 1324 S - LSK 1324C S

## Selection

IP 23S motor - IC 06 ventilation - Class H  
Full bridge three-phase power supply  
S1 duty - Ambient temperature  $\leq 40^{\circ}\text{C}$  - Total weight: 155 kg - Inertia moment: 0.12 kg.m<sup>2</sup>  
Excitation power: 0.7 kW - Maximum mechanical speed: 4000 min<sup>-1</sup>

P	Rotation speed $n$ for armature voltage $U$							$n_{max}$ elec <sup>1</sup>		M	I	$\eta$	L	$R_{115^{\circ}}$	$U_{max}$	Index	Qty
	260 V min <sup>-1</sup>	400 V min <sup>-1</sup>	420 V min <sup>-1</sup>	440 V min <sup>-1</sup>	460 V min <sup>-1</sup>	500 V min <sup>-1</sup>	600 V min <sup>-1</sup>	N.C. min <sup>-1</sup>	C. min <sup>-1</sup>								
6.9	630							1000	1600	105	39	0.68	41	2.23	550	03	
12.2		970						1550	2480	120	38.5	0.79	41	2.23	550		
12.7			1020					1630	2610	119	38	0.79	41	2.23	550		
13.3				1070				1710	2740	119	38	0.79	41	2.23	550		
14					1120			1790	2860	119	38	0.80	41	2.23	550		
15.5						1220		1950	3120	121	38	0.81	41	2.23	550		
17.9							1460		3740	117	36.5	0.82	25	2.69	600		▼
9.7	890							2000	3200	104	49.5	0.75	22	1.3	550	05	
16.5		1310						2200	3520	120	49.5	0.83	22	1.3	550		
17.3			1440					2320	3710	115	49	0.83	22	1.3	550		
18				1510				2410	3860	114	49	0.83	22	1.3	550		
18.7					1580			2520	4000	113	48.5	0.84	22	1.3	550		
20.6						1720		2750	4000	114	48.5	0.85	22	1.3	550		
23.6							2060		4000	109	46	0.86	14	1.59	600		▼
15.6	1470							2350	3760	101	73.5	0.82	10	0.56	550	08	
25.4		2260						3610	4000	107	72.5	0.87	10	0.56	550		
26.6			2380					3800	4000	107	72	0.88	10	0.56	550		
27.9				2490				3980	4000	107	72	0.88	10	0.56	550		
29.3					2600			4000	4000	108	72	0.88	10	0.56	550		
32						2830		4000	4000	108	72	0.89	10	0.56	550		
36.8							3390		4000	104	69	0.89	6.3	0.64	600		▼
19.9	1850							2400	4000	103	90	0.85	6.5	0.35	460	09	
32		2840						3260	4000	108	89.5	0.89	6.5	0.35	460		
33.4			2990					3400	4000	107	89	0.89	6.5	0.35	460		
34.4				3130				3400	4000	105	87.5	0.89	6.5	0.35	460		
35.3					3270			3470	4000	103	86	0.89	6.5	0.35	460		

1. Higher speed ranges by field weakening can be studied according to the application : consult us.

▼ : only compensated version motor: LSK 1324C S.

- P** : Rated power  
**M** : Rated moment  
**I** : Permissible current in continuous operation  
 $\eta$  : Efficiency  
**L** : Motor self-induction coil  
**R** : Armature resistance at 115°C  
 $U_{max}$  : Maximum armature voltage  
 N.C. : Non compensated motor  
 C. : Compound motor



# Open continuous current (DC) motors LSK 1324 M - LSK 1324C M

## Selection

IP 23S motor - IC 06 ventilation - Class H  
Full bridge three-phase power supply  
S1 duty - Ambient temperature  $\leq 40^{\circ}\text{C}$  - Total weight: 175 kg - Inertia moment: 0.15 kg.m<sup>2</sup>  
Excitation power: 0.8 kW - Maximum mechanical speed: 4000 min<sup>-1</sup>

P kW	Rotation speed $n$ for armature voltage $U$							$n_{max}$ elec <sup>1</sup>		M N.m	I A	$\eta$ Except for excit.	L mH	$R_{115^{\circ}}$ $\Omega$	$U_{max}$ V	Index	Qty
	260 V min <sup>-1</sup>	400 V min <sup>-1</sup>	420 V min <sup>-1</sup>	440 V min <sup>-1</sup>	460 V min <sup>-1</sup>	500 V min <sup>-1</sup>	600 V min <sup>-1</sup>	N.C. min <sup>-1</sup>	C. min <sup>-1</sup>								
8.9	620							990	1580	137	48.5	0.71	29.5	1.57	550		
15.3		960						1530	2450	152	48	0.79	29.5	1.57	550		
15.8			1000					1600	2560	151	47	0.80	29.5	1.57	550		
16.5				1050				1680	2690	150	47	0.80	29.5	1.57	550	05	
17.3					1100			1760	2820	150	47	0.80	29.5	1.57	550		
18.8						1200		1920	3070	150	47	0.80	29.5	1.57	550		
21.5							1430		4000	144	44.5	0.81	16.8	1.8	600	▼	
15.1	1040							1660	2660	139	75	0.77	12.6	0.68	550		
24.8		1600						2560	4000	148	73.5	0.84	12.6	0.68	550		
26.3			1690					2700	4000	149	73	0.85	12.6	0.68	550		
27.6				1770				2830	4000	149	73	0.86	12.6	0.68	550	08	1
29					1850			2960	4000	150	73	0.86	12.6	0.68	550		
31.5						2010		3210	4000	150	73	0.86	12.6	0.68	550		
36.4							2410		4000	144	70	0.87	7.2	0.77	600	▼	
19.2	1380							1790	2860	133	88	0.84	8	0.4	460		
30.5		2130						2450	4000	137	88	0.87	8	0.4	460		
32			2230					2500	4000	137	87.5	0.87	8	0.4	460		
33.6				2340				2500	4000	137	87.5	0.87	8	0.4	460	09	1
35.5					2450			2600	4000	138	87.5	0.88	8	0.4	460		
38.5						2660			4000	138	87.5	0.88	4.5	0.49	500	▼	
23.6	1870							2990	4000	121	108	0.84	4.6	0.25	600		
37.3		2870						4000		124	106	0.88	4.6	0.25	600		
39.2			3020					4000		124	106	0.88	4.6	0.25	600		
41.5				3160				4000		125	106	0.89	4.6	0.25	600	10	1
42.6					3300			4000		123	104	0.89	4.6	0.25	600		
45.4						3590		4000		121	101	0.90	4.6	0.25	600		

1. Higher speed ranges by field weakening can be studied according to the application : consult us.

▼ : only compensated version motor: LSK 1324C M.

- P : Rated power
- M : Rated moment
- I : Permissible current in continuous operation
- $\eta$  : Efficiency
- L : Motor self-induction coil
- R : Armature resistance at 115°C
- $U_{max}$  : Maximum armature voltage
- N.C. : Non compensated motor
- C. : Compound motor

# Open continuous current (DC) motors LSK 1324 VL - LSK 1324C VL

## Selection

**IP 23S motor - IC 06 ventilation - Class H**  
**Full bridge three-phase power supply**  
**S1 duty - Ambient temperature  $\leq 40^{\circ}\text{C}$  - Total weight: 215 kg - Inertia moment: 0.2 kg.m<sup>2</sup>**  
**Excitation power: 0.85 kW - Maximum mechanical speed: 4000 min<sup>-1</sup>**

P	Rotation speed $n$ for armature voltage $U$							$n_{max}$ elec <sup>1</sup>		M	I	$\eta$	L	$R_{115^{\circ}}$	$U_{max}$	Index	Qty
	260 V min <sup>-1</sup>	400 V min <sup>-1</sup>	420 V min <sup>-1</sup>	440 V min <sup>-1</sup>	460 V min <sup>-1</sup>	500 V min <sup>-1</sup>	600 V min <sup>-1</sup>	N.C. min <sup>-1</sup>	C. min <sup>-1</sup>								
12.7	700							960	1470	173	67	0.73	21.4	0.88	500	08	
21.4		1070						1460	2240	191	66	0.81	21.4	0.88	500		
22.7			1120					1530	2350	194	65	0.83	21.4	0.88	500		
24.2				1170				1600	2450	198	65	0.84	21.4	0.88	500		
24.9					1220			1670	2560	195	64.5	0.84	21.4	0.88	500		
26.9						1320		1800	2770	195	64	0.84	21.4	0.88	500		
32.1							1580		3300	194	63	0.85	10.1	0.88	600		▼
16.8	910							1180	1890	176	80	0.80	13.8	0.57	460	09	
27.3		1390						1600	2560	188	79.5	0.86	13.8	0.57	460		
28.8			1460					1650	2640	188	79	0.87	13.8	0.57	460		
30.2				1530				1650	2640	189	79	0.87	13.8	0.57	460		
30.5					1600			1700	2720	182	76.5	0.87	13.8	0.57	460		
33						1730			2960	182	75	0.88	7.8	0.68	500		▼
23.5	1240							1980	3170	181	105.5	0.85	8	0.33	550		10
36.8		1910						3050	4000	184	105	0.87	8	0.33	550		
38.8			2000					3200	4000	185	104.5	0.88	8	0.33	550		
40.5				2100				3360	4000	184	104.5	0.88	8	0.33	550		
41.8					2190			3500	4000	182	101.5	0.89	8	0.33	550		
44						2380		3570	4000	177	99	0.89	8	0.33	550		
51.5							2860		4000	172	96.5	0.89	4.6	0.37	600	▼	
28.1	1500							3200	4000	179	127	0.85	4.6	0.23	550	11	
44.7		2300						3400	4000	186	126.5	0.88	4.6	0.23	550		
46.6			2420					3500	4000	184	126	0.88	4.6	0.23	550		
49				2530				3500	4000	185	126	0.88	4.6	0.23	550		
49.5					2640			3500	4000	179	121	0.89	4.6	0.203	550		
52.7						2870		3500	4000	175	116	0.89	4.6	0.23	550		
61.4							3450		4000	170	111.5	0.89	2.6	0.26	600		▼
30.6	1830							2920	4000	160	135.5	0.87	3.2	0.15	460	13	
48		2820						4000		163	134	0.89	3.2	0.15	460		
49.8			2960					4000		161	133	0.89	3.2	0.15	460		
52.5				3100				4000		162	132	0.90	3.2	0.15	460		
53.2					3240			4000		157	128.5	0.90	3.2	0.15	460		
56.7						3520			4000	154	126	0.90	1.9	0.17	500		▼

1. Higher speed ranges by field weakening can be studied according to the application : consult us.

▼ : only compensated version motor: LSK 1324C VL.

P : Rated power

M : Rated moment

I : Permissible current in continuous operation

$\eta$  : Efficiency

L : Motor self-induction coil

R : Armature resistance at 115°C

$U_{max}$  : Maximum armature voltage

N.C. : Non compensated motor

C. : Compound motor

# Open continuous current (DC) motors LSK 1324 XVL - LSK 1324C XVL

## Selection

IP 23S motor - IC 06 ventilation - Class H  
Full bridge three-phase power supply  
S1 duty - Ambient temperature  $\leq 40^{\circ}\text{C}$  - Total weight: 249 kg - Inertia moment: 0.24 kg.m<sup>2</sup>  
Excitation power: 1.2 kW - Maximum mechanical speed: 4000 min<sup>-1</sup>

P kW	Rotation speed <i>n</i> for armature voltage <i>U</i>							$n_{max}$ elec <sup>1</sup>		M N.m	I A	$\eta$ Except for excit.	L mH	$R_{115^{\circ}}$ $\Omega$	$U_{max}$ V	Index	Qty
	260 V min <sup>-1</sup>	400 V min <sup>-1</sup>	420 V min <sup>-1</sup>	440 V min <sup>-1</sup>	460 V min <sup>-1</sup>	500 V min <sup>-1</sup>	600 V min <sup>-1</sup>	N.C. min <sup>-1</sup>	C. min <sup>-1</sup>								
12.9	550							750	1200	224	67	0.74	20.5	1.03	550	08	
21.8		840						1150	1840	248	66	0.83	20.5	1.03	550		
23			880					1210	1940	250	65	0.84	20.5	1.03	550		
24				920				1260	2020	249	64.5	0.84	20.5	1.03	550		
25.2					960			1320	2110	251	64.5	0.85	20.5	1.03	550		
27.5						1040		1430	2290	253	64	0.86	20.5	1.03	550		
32.5							1250		2750	248	63	0.86	13	1.15	600		▼
16.8	720							990	1580	223	81.5	0.79	13	0.64	460	09	
28		1100						1270	2030	243	81	0.86	13	0.64	460		
29.5			1160					1330	2130	243	80.5	0.87	13	0.64	460		
31				1210				1330	2130	245	80.5	0.87	13	0.64	460		
32.5					1260			1360	2180	246	80.5	0.88	13	0.64	460		
35.2						1370			2620	245	80	0.88	8.3	0.72	500		▼
22.4	970							1330	2130	221	107	0.80	7.4	0.39	550		10
36.2		1490						2050	3280	232	106	0.85	7.4	0.39	550		
38.3			1570					2160	3460	233	106	0.86	7.4	0.39	550		
40				1640				2260	3620	233	105.5	0.86	7.4	0.39	550		
42					1710			2350	3760	235	105.5	0.87	7.4	0.39	550		
45.8						1860		2410	3860	235	105	0.87	7.4	0.39	550		
54.5							2230		4000	233	104	0.88	4.8	0.44	600	▼	
27.3	1190							2200	3520	219	125	0.84	5.5	0.28	550	11	
43.8		1830						2400	3840	229	123	0.89	5.5	0.28	550		
45.6			1920					2500	4000	227	121.5	0.89	5.5	0.28	550		
47.3				2010				2610	4000	225	120	0.90	5.5	0.28	550		
49.5					2100			2730	4000	225	119.5	0.90	5.5	0.28	550		
53.8						2280		2960	4000	225	118.5	0.91	5.5	0.28	550		
64.3							2740		4000	224	118	0.91	3.5	0.32	600		▼
34	1450							2000	3200	224	149.5	0.87	3.7	0.17	460	13	
53.7		2220						2880	4000	231	147.5	0.90	3.7	0.17	460		
56.4			2330					3020	4000	231	147	0.91	3.7	0.17	460		
59.2				2440				3170	4000	232	147	0.91	3.7	0.17	460		
61.8					2550			3310	4000	231	146.5	0.92	3.7	0.17	460		
67.3						2770			4000	232	146.5	0.92	2.3	0.18	600		▼
80.2							3330		4000	230	145	0.92	2.3	0.18	600		▼

1. Higher speed ranges by field weakening can be studied according to the application : consult us.

▼ : only compensated version motor: LSK 1324C XVL.

P : Rated power

M : Rated moment

I : Permissible current in continuous operation

$\eta$  : Efficiency

L : Motor self-induction coil

R : Armature resistance at 115°C

$U_{max}$  : Maximum armature voltage

N.C. : Non compensated motor

C. : Compound motor

# Open continuous current (DC) motors LSK 1604 S - LSK 1604C S

## Selection

**IP 23S motor - IC 06 ventilation - Class H**  
**Full bridge three-phase power supply**  
**S1 duty - Ambient temperature  $\leq 40^{\circ}\text{C}$  - Total weight: 285 kg - Inertia moment: 0.45 kg.m<sup>2</sup>**  
**Excitation power: 1.3 kW - Maximum mechanical speed: 4000 min<sup>-1</sup>**

P	Rotation speed $n$ for armature voltage $U$							$n_{max}$ elec <sup>1</sup>		M	I	$\eta$ Except for excit.	L	$R_{115^{\circ}}$	$U_{max}$	Index	Qty
	260 V min <sup>-1</sup>	400 V min <sup>-1</sup>	420 V min <sup>-1</sup>	440 V min <sup>-1</sup>	460 V min <sup>-1</sup>	500 V min <sup>-1</sup>	600 V min <sup>-1</sup>	N.C. min <sup>-1</sup>	C. min <sup>-1</sup>								
20.4	680							1020	1630	287	99	0.79	9.8	0.63	600	02	
33.6		1050						1570	2510	306	98	0.86	9.8	0.63	600		
34.9			1100					1650	2640	303	96	0.86	9.8	0.63	600		
36.3				1150				1720	2750	301	95.5	0.86	9.8	0.63	600		
37.1					1200			1800	2880	295	93	0.87	9.8	0.63	600		
39.2						1300		1950	3120	288	89	0.88	9.8	0.63	600		
46.2							1560	2100	3360	283	87.5	0.88	9.8	0.63	600		
24.8	850							1270	2030	279	118	0.81	6.6	0.46	500	04	
40.4		1310						1960	3140	295	116.5	0.87	6.6	0.46	500		
42.3			1380					2070	3310	293	115	0.87	6.6	0.46	500		
44.1				1440				2160	3460	292	114.5	0.97	6.6	0.46	500		
45.2					1500			2250	3600	288	112	0.88	6.6	0.46	500		
47						1630		2400	3840	275	106	0.89	6.6	0.46	500		
55.8							1960		4000	272	104.5	0.89	3.8	0.57	600		▼
29.6	1010							1510	2420	280	137.5	0.83	4.9	0.35	460	05	
47.8		1550						2320	3710	295	136	0.88	4.9	0.35	460		
49.6			1630					2440	3900	291	134	0.88	4.9	0.35	460		
52				1700				2550	4000	292	133.5	0.89	4.9	0.35	460		
53					1770			2600	4000	286	130	0.89	4.9	0.35	460		
55						1930			4000	272	124	0.89	2.9	0.43	600	▼	
65.6							2310		4000	271	121.5	0.90	2.9	0.43	600	▼	
87.5	1250							1870	2990	287	166.5	0.87	3.3	0.2	600	06	
59.9		1910						2670	4000	300	165	0.90	3.3	0.2	600		
62			2010					2800	4000	295	162.5	0.90	3.3	0.2	600		
64.7				2100				2940	4000	294	162	0.91	3.3	0.2	600		
66.4					2190			3000	4000	290	158	0.91	3.3	0.2	600		
68.5						2380		3300	4000	275	150.5	0.91	3.3	0.2	600		
80.5							2860	4000		269	147.5	0.91	3.3	0.2	600		
45.5	1460							2190	3500	298	197	0.88	2.4	0.14	600	07	
71		2240						3100	4000	303	195	0.91	2.4	0.14	600		
73.5			2350					3290	4000	299	192	0.91	2.4	0.14	600		
77.4				2460				3400	4000	300	191	0.92	2.4	0.14	600		
79.1					2570			2590	4000	294	187	0.92	2.4	0.14	600		
81.9						2790		3900	4000	280	178	0.92	2.4	0.14	600		
96.6							3350	4000		275	175	0.92	2.4	0.14	600		
54.2	1860							2600	4000	278	234	0.89	2	0.09	500	09	
84.7		2860						4000		283	230	0.92	2	0.09	500		
87.7			3000					4000		279	227	0.92	2	0.09	500		
91				3140				4000		277	225	0.92	2	0.09	500		
95.8					3280			4000		279	224	0.93	2	0.09	500		
102						3570		4000		274	220	0.93	2	0.09	500		

1. Higher speed ranges by field weakening can be studied according to the application : consult us.

▼ : only compensated version motor: LSK 1604C S.

P : Rated power

M : Rated moment

I : Permissible current in continuous operation

$\eta$  : Efficiency

L : Motor self-induction coil

R : Armature resistance at 115°C

$U_{max}$  : Maximum armature voltage

N.C. : Non compensated motor

C. : Compound motor

# Open continuous current (DC) motors LSK 1604 M - LSK 1604C M

## Selection

IP 23S motor - IC 06 ventilation - Class H  
Full bridge three-phase power supply  
S1 duty - Ambient temperature  $\leq 40^{\circ}\text{C}$  - Total weight: 325 kg - Inertia moment: 0.55 kg.m<sup>2</sup>  
Excitation power: 1.6 kW - Maximum mechanical speed: 4000 min<sup>-1</sup>

P kW	Rotation speed $n$ for armature voltage $U$							$\eta_{elec}$		M N.m	I A	$\eta$ Except for excit.	L mH	$R_{115^{\circ}}$ $\Omega$	$U_{max}$ V	Index	Qty
	260 V min <sup>-1</sup>	400 V min <sup>-1</sup>	420 V min <sup>-1</sup>	440 V min <sup>-1</sup>	460 V min <sup>-1</sup>	500 V min <sup>-1</sup>	600 V min <sup>-1</sup>	N.C. min <sup>-1</sup>	C. min <sup>-1</sup>								
24.3	620						930	1490	374	121.5	0.77	8.8	0.562	500	04		
40.2		950					1330	2130	404	119.5	0.84	8.8	0.562	500			
42.3			990				1380	2210	408	118.5	0.85	8.8	0.562	500			
44.1				1040			1450	2320	405	117.5	0.86	8.8	0.562	500			
45.4					1080		1510	2420	401	114.5	0.86	8.8	0.562	500			
47.8						1180	1650	2640	387	110	0.87	8.8	0.562	500			
56.2								3170	381	107.5	0.87	5	0.562	600		▼	
29	740						1110	1780	374	140	0.80	6.5	0.429	460	05		
47.4		1130					1580	2530	401	138	0.85	6.5	0.429	460			
49.4			1190				1660	2660	396	136.5	0.86	6.5	0.429	460			
52				1240			1730	2770	400	135.5	0.87	6.5	0.429	460			
53.2					1290		1800	2880	394	132.5	0.87	6.5	0.429	460			
56.3						1400		3110	384	128	0.88	3.7	0.53	600		▼	
65.5								3730	370	124	0.88	3.7	0.53	600		▼	
37.9	910						1360	2180	398	171.5	0.85	4.4	0.249	600	06		
60.3		1390					1940	3100	414	169.5	0.89	4.4	0.249	600			
62.8			1460				2040	3260	411	168	0.89	4.4	0.249	600			
65.2				1530			2140	3420	407	166.5	0.89	4.4	0.249	600			
67					1590		2220	3550	402	162	0.90	4.4	0.249	600			
70.2						1730	2400	3840	388	156	0.90	4.4	0.249	600			
82.4							2700	4000	378	152.5	0.90	4.4	0.249	600			
46	1070						1710	2740	411	203	0.87	4.1	0.169	600	07		
72.7		1650					2360	3780	421	201.5	0.90	4.1	0.169	600			
75			1730				2400	3840	414	198.5	0.90	4.1	0.169	600			
78.3				1800			2500	4000	415	197.5	0.90	4.1	0.169	600			
81					1870		2610	4000	414	193	0.91	4.1	0.169	600			
83.8						2040	2840	4000	392	184	0.91	4.1	0.169	600			
98.3							3400	4000	383	180	0.91	4.1	0.169	600			
65	1580						2370	3790	393	280	0.89	1.57	0.08	460	10		
101		2420					3140	4000	399	275	0.92	1.57	0.08	460			
105			2540				3300	4000	395	272	0.92	1.57	0.08	460			
109				2660			3450	4000	392	270	0.92	1.57	0.08	460			
114					2780		3600	4000	392	269.5	0.92	1.57	0.08	460			
123						3020		4000	388	264	0.93	0.9	0.1	600		▼	
145								3620	383	260	0.93	0.9	0.1	600		▼	
74	1770						2440	3900	399	315	0.90	1.77	0.07	500	11		
108		2740					3750	4000	376	295	0.91	1.77	0.07	500			
111			2870				3930	4000	369	290	0.91	1.77	0.07	500			
117				3000			4000		372	289	0.92	1.77	0.07	500			
122					3130		4000		372	286	0.93	1.77	0.07	500			
131						3400	4000		368	281	0.93	1.77	0.07	500			

1. Higher speed ranges by field weakening can be studied according to the application : consult us.

▼ : only compensated version motor: LSK 1604C M.

P : Rated power

M : Rated moment

I : Permissible current in continuous operation

$\eta$  : Efficiency

L : Motor self-induction coil

R : Armature resistance at 115°C

$U_{max}$  : Maximum armature voltage

N.C. : Non compensated motor

C. : Compound motor

# Open continuous current (DC) motors LSK 1604 L - LSK 1604C L

## Selection

**IP 23S motor - IC 06 ventilation - Class H**  
**Full bridge three-phase power supply**  
**S1 duty - Ambient temperature  $\leq 40^{\circ}\text{C}$  - Total weight: 375 kg - Inertia moment: 0.6 kg.m<sup>2</sup>**  
**Excitation power: 1.4 kW - Maximum mechanical speed: 4000 min<sup>-1</sup>**

P	Rotation speed $n$ for armature voltage $U$							$n_{max}$ elec <sup>1</sup>		M	I	$\eta$	L	$R_{115^{\circ}}$	$U_{max}$	Index	Qty
	260 V min <sup>-1</sup>	400 V min <sup>-1</sup>	420 V min <sup>-1</sup>	440 V min <sup>-1</sup>	460 V min <sup>-1</sup>	500 V min <sup>-1</sup>	600 V min <sup>-1</sup>	N.C. min <sup>-1</sup>	C. min <sup>-1</sup>								
26.4	610							910	1460	413	130	0.78	8.25	0.49	460	05	
43.7		930						1300	2080	449	130	0.84	8.25	0.49	460		
46.4			980					1370	2190	452	130	0.85	8.25	0.49	460		
49				1020				1420	2270	459	130	0.86	8.25	0.49	460		
50.5					1060			1480	2370	455	127	0.86	8.25	0.49	460		
52.5						1150			2560	436	121	0.87	4.7	0.61	600		▼
62							1390		3070	426	118.5	0.87	4.7	0.61	600	▼	
36.7	740							1100	1760	474	170	0.83	5.22	0.284	600	06	
59.2		1130						1580	2530	500	170	0.87	5.22	0.284	600		
62.8			1190					1660	3660	504	170	0.88	5.22	0.284	600		
66				1240				1730	2770	508	170	0.88	5.22	0.284	600		
68					1290			1800	2880	503	166	0.89	5.22	0.284	600		
70.8						1400		1960	3140	483	158.5	0.90	5.22	0.284	600		
82.8							1690	2190	3500	468	155	0.90	5.22	0.284	600		
41.6	970							1530	2450	410	198	0.85	3.83	0.193	600	07	
66.2		1480						2180	3490	427	198	0.88	3.83	0.193	600		
70.3			1560					2290	3660	430	198	0.89	3.83	0.193	600		
74.4				1620				2390	3820	439	198	0.89	3.83	0.193	600		
76.5					1690			2490	3980	432	193.5	0.90	3.83	0.193	600		
80.2						1840		2650	4000	416	185.5	0.91	3.83	0.193	600		
94.5							2210	3020	4000	408	182	0.91	3.83	0.193	600		
52.4	1160							1740	2780	431	231.5	0.87	2.53	0.132	500	09	
83.3		1780						2450	3920	447	231.5	0.90	2.53	0.132	500		
88.5			1870					2430	3890	452	231.5	0.91	2.53	0.132	500		
92.7				1950				2530	4000	454	231.5	0.91	2.53	0.132	500		
96.9					2030			2630	4000	456	230	0.91	2.53	0.132	500		
104						2210		2870	4000	449	226	0.92	2.53	0.132	500		
123							2650	4000	441	441	222	0.92	1.4	0.16	600	▼	
62.7	1310							2070	3310	457	271	0.89	1.92	0.093	460	10	
98.7		2020						2760	4000	467	271	0.91	1.92	0.093	460		
105			2120					2890	4000	472	271	0.92	1.92	0.093	460		
110				2230				3020	4000	470	271	0.92	1.92	0.093	460		
113					2330			3150	4000	462	266.5	0.92	1.92	0.093	460		
118						2530		4000	447	447	257	0.92	1.1	0.11	600		▼
139							3040	4000	436	436	251.5	0.92	1.1	0.11	600	▼	
70.6	1780							2490	3980	379	305	0.89	1.62	0.06	600	12	
111		2730						3540	4000	388	305	0.91	1.62	0.06	600		
117			2870					3730	4000	388	305	0.91	1.62	0.06	600		
124				3000				3900	4000	393	305	0.92	1.62	0.06	600		
130					3130			4000		397	304	0.93	1.62	0.06	600		
140						3400		4000		392	300	0.93	1.62	0.06	600		

1. Higher speed ranges by field weakening can be studied according to the application : consult us.

▼ : only compensated version motor: LSK 1604C L.

P : Rated power

M : Rated moment

I : Permissible current in continuous operation

$\eta$  : Efficiency

L : Motor self-induction coil

R : Armature resistance at 115°C

$U_{max}$  : Maximum armature voltage

N.C. : Non compensated motor

C. : Compound motor

# Open continuous current (DC) motors LSK 1604 VL - LSK 1604C VL

## Selection

**IP 23S motor - IC 06 ventilation - Class H**  
**Full bridge three-phase power supply**  
**S1 duty - Ambient temperature  $\leq 40^{\circ}\text{C}$  - Total weight: 450 kg - Inertia moment: 0.65 kg.m<sup>2</sup>**  
**Excitation power: 2.1 kW - Maximum mechanical speed: 4000 min<sup>-1</sup>**

P kW	Rotation speed $n$ for armature voltage $U$							$\eta_{elec}$		M N.m	I A	$\eta$ Except for excit.	L mH	$R_{115^{\circ}}$ $\Omega$	$U_{max}$ V	Index	Qty
	260 V min <sup>-1</sup>	400 V min <sup>-1</sup>	420 V min <sup>-1</sup>	440 V min <sup>-1</sup>	460 V min <sup>-1</sup>	500 V min <sup>-1</sup>	600 V min <sup>-1</sup>	N.C. min <sup>-1</sup>	C. min <sup>-1</sup>								
30.3	560						840	1340	517	151.5	0.77	7	0.35	600	06		
50.3		860					1160	1860	559	151.5	0.83	7	0.35	600			
53.5			900				1215	1940	568	151.5	0.84	7	0.35	600			
56.2				940			1270	2030	571	151.5	0.84	7	0.35	600			
58.8					980		1320	2110	573	151	0.85	7	0.35	600			
64.2						1060	1430	2290	578	150	0.86	7	0.35	600			
75.8							1280	1720	2750	566	147	0.86	7	0.35		600	
37.4	650						970	1550	549	179.5	0.80	7.5	0.249	600	07		
61.8		1000					1350	2160	590	179.5	0.86	7.5	0.249	600			
64.8			1050				1410	2260	589	179.5	0.86	7.5	0.249	600			
68.4				1100			1480	2370	594	179.5	0.87	7.5	0.249	600			
71.5					1150		1550	2480	594	179	0.87	7.5	0.249	600			
77.4						1250	1680	2690	591	177	0.88	7.5	0.249	600			
92.1								1500	2000	3200	586	174.5	0.88	7.5		0.249	600
47.4	830						1240	1980	545	219.5	0.83	4.8	0.16	500	09		
75.5		1280					1720	2750	563	219.5	0.86	4.8	0.16	500			
79.3			1340				1800	2880	565	219.5	0.86	4.8	0.16	500			
84.6				1400			1890	3020	577	219.5	0.87	4.8	0.16	500			
88.5					1460		1970	3150	579	219	0.88	4.8	0.16	500			
95.4						1590	2140	3420	573	217	0.88	4.8	0.16	500			
114								1900	4000	573	213.5	1.7	0.2	600		▼	
55.5	990						1480	2370	535	254	0.84	3.5	0.12	460	10		
88.4		1510					2030	3250	559	254	0.87	3.5	0.12	460			
93.9			1590				2140	3420	564	254	0.88	3.5	0.12	460			
99				1660			2240	3580	570	254	0.88	3.5	0.12	460			
104					1730		2300	3680	571	253	0.89	3.5	0.12	460			
111						1880		3970	565	250	0.89	1.3	0.14	600		▼	
133							2260	4000	562	246.5	0.90	1.3	0.14	600		▼	
69	1230						1840	2940	536	305	0.87	2.4	0.083	600	12		
110		1900					2310	3700	552	305	0.90	2.4	0.083	600			
115			1990				2420	3870	553	305	0.90	2.4	0.083	600			
123				2080			2530	4000	563	305	0.91	2.4	0.083	600			
128					2170		2640	4000	561	304	0.91	2.4	0.083	600			
138						2360	2800	4000	558	300	0.92	2.4	0.083	600			
163							2830	3400	4000	551	296	0.92	2.4	0.083		600	
81.4	1600						1950	4000	486	360	0.87	1.5	0.04	500	13		
130		2460					3000	4000	503	360	0.90	1.5	0.04	500			
136			2580				3140	4000	503	360	0.90	1.5	0.04	500			
145				2700			3290	4000	512	360	0.91	1.5	0.04	500			
147					2820		3430	4000	496	350	0.91	1.5	0.04	500			
156						3060	3730	4000	488	340	0.92	1.5	0.04	500			

1. Higher speed ranges by field weakening can be studied according to the application : consult us.

▼ : only compensated version motor: LSK 1604C VL.

P : Rated power

M : Rated moment

I : Permissible current in continuous operation

$\eta$  : Efficiency

L : Motor self-induction coil

R : Armature resistance at 115°C

$U_{max}$  : Maximum armature voltage

N.C. : Non compensated motor

C. : Compound motor

# Open continuous current (DC) motors LSK 1804 M

## Selection

**IP 23S motor - IC 06 ventilation - Class H**  
**Full bridge three-phase power supply**  
**S1 duty - Ambient temperature  $\leq 40^{\circ}\text{C}$  - Total weight: 480 kg - Inertia moment: 0.7 kg.m<sup>2</sup>**  
**Excitation power: 1.9 kW - Maximum mechanical speed: 3600 min<sup>-1</sup>**

P	Rotation speed $n$ for armature voltage $U$							$n_{max}$	M	I	$\eta$	L	$R_{115^{\circ}}$	$U_{max}$	Index	Qty
	260 V min <sup>-1</sup>	400 V min <sup>-1</sup>	420 V min <sup>-1</sup>	440 V min <sup>-1</sup>	460 V min <sup>-1</sup>	500 V min <sup>-1</sup>	600 V min <sup>-1</sup>									
40.8	680							1290	573	194	0.81	7	0.19	600	03	
67.2		1050						1780	611	193	0.87	7	0.19	600		
71			1100					1870	616	192	0.88	7	0.19	600		
74.3				1150				1950	617	192	0.88	7	0.19	600		
76.1					1200			2040	606	188	0.88	7	0.19	600		
81.6						1300		2170	599	185	0.88	7	0.19	600		
96							1560	2300	588	180	0.89	7	0.19	600		
51.5	810							1010	607	240	0.83	4.9	0.13	550	04	
83.5		1240						1550	643	237	0.88	4.9	0.13	550		
87.3			1300					1620	641	234	0.89	4.9	0.13	550		
90.9				1360				1700	638	232	0.89	4.9	0.13	550		
94.9					1420			1770	638	230	0.90	4.9	0.13	550		
102						1540		1920	631	226	0.90	4.9	0.13	550		
57.5	940							1320	584	260	0.85	3.6	0.1	500		
91.2		1450						2040	601	256	0.89	3.6	0.1	500		
96			1520					2140	603	254	0.90	3.6	0.1	500		
100				1590				2240	602	253	0.90	3.6	0.1	500		
104					1660			2300	597	248	0.91	3.6	0.1	500		
112						1800		2340	592	245	0.91	3.6	0.1	500		
77.8	1240							1550	599	340	0.88	2.2	0.055	600	06	
122		1910						2290	610	335	0.91	2.2	0.055	600		
127			2010					2410	601	330	0.91	2.2	0.055	600		
131				2100				2520	596	325	0.92	2.2	0.055	600		
135					2190			2620	588	320	0.92	2.2	0.055	600		
143						2380		2850	573	310	0.92	2.2	0.055	600		
169							2860	3430	564	305	0.92	2.2	0.055	600		
89.2	1420							1980	600	390	0.88	1.8	0.045	600	10	
132		2180						2700	577	370	0.89	1.8	0.045	600		
142			2290					2840	593	368	0.92	1.8	0.045	600		
148				2390				2960	591	366	0.92	1.8	0.045	600		
150					2490			3080	575	354	0.92	1.8	0.045	600		
157						2710		3360	553	340	0.92	1.8	0.045	600		
183							3250	3800	538	330	0.93	1.8	0.045	600		
82.4	1600							2000	492	360	0.88	1.6	0.038	550	11	
114		2460						2830	443	320	0.89	1.6	0.038	550		
122			2580					2970	452	316	0.92	1.6	0.038	550		
128				2700				3110	451	315	0.92	1.6	0.038	550		
132					2820			3200	447	312	0.92	1.6	0.038	550		
143						3060		3300	445	310	0.92	1.6	0.038	550		

1. Higher speed ranges by field weakening can be studied according to the application : consult us.

P : Rated power  
M : Rated moment  
I : Permissible current in continuous operation  
 $\eta$  : Efficiency  
L : Motor self-induction coil  
R : Armature resistance at 115°C  
 $U_{max}$  : Maximum armature voltage



# Open continuous current (DC) motors LSK 1804 L

## Selection

**IP 23S motor - IC 06 ventilation - Class H**  
**Full bridge three-phase power supply**  
**S1 duty - Ambient temperature  $\leq 40^{\circ}\text{C}$  - Total weight: 515 kg - Inertia moment: 0.8 kg.m<sup>2</sup>**  
**Excitation power: 2 kW - Maximum mechanical speed: 3600 min<sup>-1</sup>**

P	Rotation speed $n$ for armature voltage $U$							$n_{maxi}$	M	I	$\eta$	L	$R_{115^{\circ}}$	$U_{max}$	Index	Qty	
	260 V min <sup>-1</sup>	400 V min <sup>-1</sup>	420 V min <sup>-1</sup>	440 V min <sup>-1</sup>	460 V min <sup>-1</sup>	500 V min <sup>-1</sup>	600 V min <sup>-1</sup>										Elec <sup>1</sup> min <sup>-1</sup>
40.4	600							1260	643	194	0.80	9.2	0.223	600	03		
66.4		920						1560	689	193	0.86	9.2	0.223	600			
70.2			970					1650	691	192	0.87	9.2	0.223	600			
74.2				1010				1710	703	192	0.88	9.2	0.223	600			
76.1					1050			1760	692	188	0.88	9.2	0.223	600			
81.6						1140		1800	684	185	0.88	9.2	0.223	600			
96							1370	2020	669	180	0.89	9.2	0.223	600			
50.7	710							880	682	238	0.82	6.4	0.16	550	04		
83		1090						1360	727	236	0.88	6.4	0.16	550			
86.5			1150					1430	718	234	0.88	6.4	0.16	550			
90.9				1200				1500	723	232	0.89	6.4	0.16	550			
94.2					1250			1560	720	230	0.89	6.4	0.16	550			
102						1360		1700	714	226	0.90	6.4	0.16	550			
57.5	830							1170	662	260	0.85	4.7	0.128	500	05		
91.2		1280						1790	680	256	0.89	4.7	0.128	500			
96			1340					1880	684	254	0.90	4.7	0.128	500			
100				1400				1960	684	253	0.90	4.7	0.128	500			
103					1460			2000	672	248	0.90	4.7	0.128	500			
112						1590		2070	670	245	0.91	4.7	0.128	500			
77.8	1100							1370	675	340	0.88	2.6	0.065	600	06	1	
122		1690						2110	689	335	0.91	2.6	0.065	600			
126			1770					2210	681	330	0.91	2.6	0.065	600			
130				1850				2220	671	325	0.91	2.6	0.065	600			
135					1930			2310	666	320	0.91	2.6	0.065	600			
143						2100		2520	648	310	0.92	2.6	0.065	600			
169							2520	3020	640	305	0.92	2.6	0.065	600			
89.2	1250							1750	681	390	0.88	2	0.053	600	10		
132		1920						2380	655	370	0.89	2	0.053	600			
142			2020					2500	672	368	0.92	2	0.053	600			
148				2110				2610	670	366	0.92	2	0.053	600			
150					2200			2720	651	354	0.92	2	0.053	600			
157						2390		2900	627	340	0.92	2	0.053	600			
183							2870	3500	610	330	0.93	2	0.053	600			

1. Higher speed ranges by field weakening can be studied according to the application : consult us.

P : Rated power  
M : Rated moment  
I : Permissible current in continuous operation  
 $\eta$  : Efficiency  
L : Motor self-induction coil  
R : Armature resistance at 115°C  
 $U_{max}$  : Maximum armature voltage

# Open continuous current (DC) motors LSK 1804 VL

## Selection

IP 23S motor - IC 06 ventilation - Class H  
Full bridge three-phase power supply  
S1 duty - Ambient temperature  $\leq 40^{\circ}\text{C}$  - Total weight: 620 kg - Inertia moment: 1 kg.m<sup>2</sup>  
Excitation power: 2.1 kW - Maximum mechanical speed: 3600 min<sup>-1</sup>

P	Rotation speed $n$ for armature voltage $U$							$n_{max}$	M	I	$\eta$	L	$R_{115^{\circ}}$	$U_{max}$	Index	Qty
	260 V min <sup>-1</sup>	400 V min <sup>-1</sup>	420 V min <sup>-1</sup>	440 V min <sup>-1</sup>	460 V min <sup>-1</sup>	500 V min <sup>-1</sup>	600 V min <sup>-1</sup>									
28.3	280							600	965	145	0.75	27	0.54	500	02	
46.3		420						650	1053	143	0.81	27	0.54	500		
49.1			440					680	1066	143	0.82	27	0.54	500		
51.5				460				700	1069	143	0.82	27	0.54	500		
54.6					480			740	1086	143	0.83	27	0.54	500		
58.8						520		800	1080	140	0.84	27	0.54	500		
43.8	400							960	1046	213	0.79	11	0.23	600	03	
71.3		680						1200	1001	205	0.87	11	0.23	600		
76.6			720					1250	1016	205	0.89	11	0.23	600		
81.6				750				1300	1039	205	0.90	11	0.23	600		
82.8					780			1360	1014	200	0.90	11	0.23	600		
87.8						850		1470	986	195	0.90	11	0.23	600		
103							1010	1760	970	190	0.90	11	0.23	600	04	
49	480							730	975	235	0.80	9.3	0.19	550		
79.4		800						1130	948	223	0.89	9.3	0.19	550		
84.2			850					1200	946	223	0.90	9.3	0.19	550		
88.3				880				1240	958	223	0.90	9.3	0.19	550		
91.5					910			1280	960	221	0.90	9.3	0.19	550		
98.7						1000		1400	943	217	0.91	9.3	0.19	550	05	
54.8	560							860	935	257	0.82	6.9	0.14	500		
87.6		920						1310	909	246	0.89	6.9	0.14	500		
93			970					1380	916	246	0.90	6.9	0.14	500		
98.5				1010				1440	931	246	0.91	6.9	0.14	500		
101					1050			1490	918	241	0.91	6.9	0.14	500		
109						1150		1630	903	239	0.91	6.9	0.14	500		

1. Higher speed ranges by field weakening can be studied according to the application : consult us.

P : Rated power  
M : Rated moment  
I : Permissible current in continuous operation  
 $\eta$  : Efficiency  
L : Motor self-induction coil  
R : Armature resistance at 115°C  
 $U_{max}$  : Maximum armature voltage

# Open continuous current (DC) motors LSK 1804 VL

## Selection

IP 23S moteur - IC 06 ventilation - Class H  
Full bridge three-phase power supply  
S1 duty - Ambient temperature  $\leq 40^{\circ}\text{C}$  - Total weight: 620 kg - Inertia moment: 1 kg.m<sup>2</sup>  
Excitation power: 2.1 kW - Maximum mechanical speed: 3600 min<sup>-1</sup>

P	Rotation speed $n$ for armature voltage $U$							$n_{maxi}$	M	I	$\eta$	L	$R_{115^{\circ}}$	$U_{max}$	Index	Qty
	260 V min <sup>-1</sup>	400 V min <sup>-1</sup>	420 V min <sup>-1</sup>	440 V min <sup>-1</sup>	460 V min <sup>-1</sup>	500 V min <sup>-1</sup>	600 V min <sup>-1</sup>									
79.5	750							1050	1012	360	0.85	3.2	0.07	600	06	
118		1230						1540	916	334	0.90	3.2	0.07	600		
126			1290					1600	933	334	0.91	3.2	0.07	600		
134				1350				1680	948	334	0.92	3.2	0.07	600		
140					1400			1750	955	332	0.92	3.2	0.07	600		
150						1520		1900	942	327	0.92	3.2	0.07	600		
178							1830	2280	929	322	0.92	3.2	0.07	600		
81.8	900							1280	868	370	0.85	2.6	0.06	600		
129		1380						1690	893	360	0.91	2.6	0.06	600	10	
136			1460					1780	890	360	0.92	2.6	0.06	600		
143				1520				1860	898	360	0.92	2.6	0.06	600		
144					1580			1930	870	348	0.92	2.6	0.06	600		
151						1720		2000	838	334	0.92	2.6	0.06	600		
179							2060	2420	830	325	0.92	2.6	0.06	600		
89.4	1160							1620	736	395	0.87	1.9	0.045	570	11	1
136		1790						2140	726	382	0.89	1.9	0.045	570		
148			1870					2240	756	382	0.92	1.9	0.045	570		
155				1960				2350	755	382	0.92	1.9	0.045	570		
161					2040			2400	754	379	0.92	1.9	0.045	570		
175						2210		2600	756	375	0.93	1.9	0.045	570		

1. Higher speed ranges by field weakening can be studied according to the application : consult us.

P : Rated power  
M : Rated moment  
I : Permissible current in continuous operation  
 $\eta$  : Efficiency  
L : Motor self-induction coil  
R : Armature resistance at 115°C  
 $U_{max}$  : Maximum armature voltage

# Open continuous current (DC) motors LSK 1804C M

## Selection

IP 23S motor - IC 06 ventilation - Class H  
Full bridge three-phase power supply  
S1 duty - Ambient temperature  $\leq 40^{\circ}\text{C}$  - Total weight: 480 kg - Inertia moment: 0.7 kg.m<sup>2</sup>  
Excitation power: 1.9 kW - Maximum mechanical speed: 3600 min<sup>-1</sup>

P	Rotation speed $n$ for armature voltage $U$							$n_{max}$	M	I	$\eta$	L	$R_{115^{\circ}}$	$U_{max}$	Index	Qty
	260 V min <sup>-1</sup>	400 V min <sup>-1</sup>	420 V min <sup>-1</sup>	440 V min <sup>-1</sup>	460 V min <sup>-1</sup>	500 V min <sup>-1</sup>	600 V min <sup>-1</sup>									
25.4	440							790	551	130	0.75	1.8	0.49	550	01	
43.2		680						1225	607	130	0.83	1.8	0.49	550		
45.9			710					1280	617	130	0.84	1.8	0.49	550		
48.3				740				1330	623	130	0.85	1.8	0.49	550		
50.8					780			1390	622	130	0.85	1.8	0.49	550		
55.9						850		1510	628	130	0.86	1.8	0.49	550		
29.6	490							880	577	147	0.78	1.5	0.39	500	02	
49.7		750						1350	633	147	0.85	1.5	0.39	500		
52.5			790					1420	635	147	0.85	1.5	0.39	500		
55.3				830				1490	636	147	0.86	1.5	0.39	500		
58.2					870			1560	639	147	0.86	1.5	0.39	500		
63.9						940		1690	649	147	0.87	1.5	0.39	500		
34.3	560							1010	585	165	0.80	1.2	0.306	500	03	
56.8		860						1550	631	165	0.86	1.2	0.306	500		
59.9			900					1620	636	165	0.87	1.2	0.306	500		
63.2				950				1710	635	165	0.87	1.2	0.306	500		
66.4					990			1790	641	165	0.88	1.2	0.306	500		
72.6						1080		1940	642	165	0.88	1.2	0.306	500		
42.8	680							1225	601	200	0.82	0.83	0.217	700	04	
70		1050						1890	637	200	0.88	0.83	0.217	700		
73.9			1100					1980	642	200	0.88	0.83	0.217	700		
77.6				1150				2070	644	200	0.88	0.83	0.217	700		
81.4					1200			2160	648	200	0.89	0.83	0.217	700		
89						1310		2350	649	200	0.89	0.83	0.217	700		
107							1570	2820	650	200	0.89	0.83	0.217	700		
53	850							1530	595	240	0.85	0.55	0.146	600	05	
85.4		1310						2360	623	240	0.89	0.55	0.146	600		
89.7			1370					2470	625	240	0.89	0.55	0.146	600		
94				1440				2590	623	240	0.89	0.55	0.146	600		
99.4					1500			2710	633	240	0.90	0.55	0.146	600		
109						1630		2940	636	240	0.91	0.55	0.146	600		
131							1960	3530	638	240	0.91	0.55	0.146	600		

1. Higher speed ranges by field weakening can be studied according to the application : consult us.

P : Rated power  
M : Rated moment  
I : Permissible current in continuous operation  
 $\eta$  : Efficiency  
L : Motor self-induction coil  
R : Armature resistance at 115°C  
 $U_{max}$  : Maximum armature voltage

# Open continuous current (DC) motors LSK 1804C M

## Selection

IP 23S motor - IC 06 ventilation - Class H  
Full bridge three-phase power supply  
S1 duty - Ambient temperature  $\leq 40^{\circ}\text{C}$  - Total weight: 480 kg - Inertia moment: 0.7 kg.m<sup>2</sup>  
Excitation power: 1.9 kW - Maximum mechanical speed: 3600 min<sup>-1</sup>

P	Rotation speed $n$ for armature voltage $U$							$n_{max}$	M	I	$\eta$	L	$R_{115^{\circ}}$	$U_{max}$	Index	Qty
	260 V min <sup>-1</sup>	400 V min <sup>-1</sup>	420 V min <sup>-1</sup>	440 V min <sup>-1</sup>	460 V min <sup>-1</sup>	500 V min <sup>-1</sup>	600 V min <sup>-1</sup>									
59.5	940							1690	604	266	0.86	0.46	0.123	550	06	
94.7		1450						2610	624	266	0.89	0.46	0.123	550		
99.4			1520					2740	625	266	0.89	0.46	0.123	550		
104				1590				2860	626	266	0.89	0.46	0.123	550		
110					1660			2990	633	266	0.90	0.46	0.123	550		
120						1810		3250	635	266	0.91	0.46	0.123	550		
66.7	1050							1890	607	295	0.87	0.37	0.097	500	07	
106		1620						2920	626	295	0.90	0.37	0.097	500		
112			1700					3060	626	295	0.90	0.37	0.097	500		
118				1780				3200	630	295	0.91	0.37	0.097	500		
123					1860			3340	632	295	0.91	0.37	0.097	500		
134						2020		3600	634	295	0.91	0.37	0.097	500		
75.5	1200							2160	601	330	0.88	0.3	0.076	500	08	
118		1850						3330	608	325	0.91	0.3	0.076	500		
120			1940					3490	593	315	0.91	0.3	0.076	500		
124				2030				3600	584	310	0.91	0.3	0.076	500		
128					2120			3600	575	305	0.91	0.3	0.076	500		
137						2310		3600	566	300	0.91	0.3	0.076	500		
87.9	1410							2540	595	383	0.88	0.22	0.061	700	10	
130		2170						3600	571	357	0.91	0.22	0.061	700		
130			2280					3600	544	340	0.91	0.22	0.061	700		
132				2390				3600	528	330	0.91	0.22	0.061	700		
132					2490			3600	507	315	0.91	0.22	0.061	700		
139						2710		3600	490	305	0.91	0.22	0.061	700		
161							3250	3600	473	294	0.91	0.22	0.061	700		

1. Higher speed ranges by field weakening can be studied according to the application : consult us.

P : Rated power  
M : Rated moment  
I : Permissible current in continuous operation  
 $\eta$  : Efficiency  
L : Motor self-induction coil  
R : Armature resistance at 115°C  
 $U_{max}$  : Maximum armature voltage

# Open continuous current (DC) motors LSK 1804C L

## Selection

IP 23S motor - IC 06 ventilation - Class H  
Full bridge three-phase power supply  
S1 duty - Ambient temperature  $\leq 40^{\circ}\text{C}$  - Total weight: 515 kg - Inertia moment: 0.8 kg.m<sup>2</sup>  
Excitation power: 2 kW - Maximum mechanical speed: 3600 min<sup>-1</sup>

P	Rotation speed $n$ for armature voltage $U$							$n_{max}$	M	I	$\eta$	L	$R_{115^{\circ}}$	$U_{max}$	Index	Qty
	260 V min <sup>-1</sup>	400 V min <sup>-1</sup>	420 V min <sup>-1</sup>	440 V min <sup>-1</sup>	460 V min <sup>-1</sup>	500 V min <sup>-1</sup>	600 V min <sup>-1</sup>									
24.9	380							685	626	130	0.74	2.1	0.52	550	01	
42.7		580						1045	703	130	0.82	2.1	0.52	550		
45.3			610					1100	709	130	0.83	2.1	0.52	550		
47.8				640				1150	713	130	0.84	2.1	0.52	550		
50.3					670			1200	717	130	0.84	2.1	0.52	550		
55.3						730		1310	723	130	0.85	2.1	0.52	550		
29.2	430							775	649	147	0.77	1.7	0.412	500	02	
49.4		660						1190	715	147	0.84	1.7	0.412	500		
52.2			690					1240	722	147	0.85	1.7	0.412	500		
55				730				1310	720	147	0.85	1.7	0.412	500		
57.8					760			1370	726	147	0.86	1.7	0.412	500		
63.6						830		1490	732	147	0.87	1.7	0.412	500		
33.9	490							880	661	165	0.79	1.35	0.324	500	03	
56.4		750						1350	718	165	0.86	1.35	0.324	500		
59.6			790					1420	720	165	0.86	1.35	0.324	500		
62.8				830				1490	723	165	0.87	1.35	0.324	500		
66					870			1560	724	165	0.87	1.35	0.324	500		
72.4						940		1690	736	165	0.88	1.35	0.324	500		
42.4	600							1190	675	200	0.82	0.94	0.23	700	04	
69.6		920						1660	722	200	0.87	0.94	0.23	700		
73.5			970					1750	724	200	0.88	0.94	0.23	700		
77.4				1020				1840	725	200	0.88	0.94	0.23	700		
81.4					1060			1920	733	200	0.89	0.94	0.23	700		
89						1150		2090	739	200	0.89	0.94	0.23	700		
107							1380	2510	739	200	0.89	0.94	0.23	700		
52.5	750							1350	669	240	0.84	0.63	0.155	600	05	
85		1150						2070	706	240	0.89	0.63	0.155	600		
89.7			1210					2180	708	240	0.89	0.63	0.155	600		
94.3				1270				2290	709	240	0.89	0.63	0.155	600		
98.9					1330			2390	710	240	0.90	0.63	0.155	600		
108						1440		2600	717	240	0.90	0.63	0.155	600		
130							1730	3120	715	240	0.90	0.63	0.155	600		

1. Higher speed ranges by field weakening can be studied according to the application : consult us.

P : Rated power  
M : Rated moment  
I : Permissible current in continuous operation  
 $\eta$  : Efficiency  
L : Motor self-induction coil  
R : Armature resistance at 115°C  
 $U_{max}$  : Maximum armature voltage

# Open continuous current (DC) motors LSK 1804C L

## Selection

IP 23S motor - IC 06 ventilation - Class H  
Full bridge three-phase power supply  
S1 duty - Ambient temperature  $\leq 40^{\circ}\text{C}$  - Total weight: 515 kg - Inertia moment: 0.8 kg.m<sup>2</sup>  
Excitation power: 2 kW - Maximum mechanical speed: 3600 min<sup>-1</sup>

P	Rotation speed $n$ for armature voltage $U$							$n_{max}$	M	I	$\eta$	L	$R_{115^{\circ}}$	$U_{max}$	Index	Qty
	260 V min <sup>-1</sup>	400 V min <sup>-1</sup>	420 V min <sup>-1</sup>	440 V min <sup>-1</sup>	460 V min <sup>-1</sup>	500 V min <sup>-1</sup>	600 V min <sup>-1</sup>									
58.9	820							1480	686	266	0.85	0.52	0.13	550	06	
94.8		1260						2270	719	266	0.89	0.52	0.13	550		
100			1320					2380	723	266	0.90	0.52	0.13	550		
105				1390				2500	722	266	0.90	0.52	0.13	550		
110					1450			2610	725	266	0.90	0.52	0.13	550		
120						1580		2840	728	266	0.91	0.52	0.13	550		
66	920							1660	685	295	0.86	0.42	0.103	500	07	
102		1420						2560	687	295	0.87	0.42	0.103	500		
109			1490					2680	699	295	0.88	0.42	0.103	500		
117				1560				2810	718	295	0.90	0.42	0.103	500		
123					1630			2930	721	295	0.91	0.42	0.103	500		
134						1770		3190	724	295	0.91	0.42	0.103	500		
75.2	1040							1870	691	330	0.88	0.34	0.081	500	08	
120		1600						2880	713	330	0.91	0.34	0.081	500		
126			1680					3020	715	330	0.91	0.34	0.081	500		
132				1760				3170	716	330	0.91	0.34	0.081	500		
138					1840			3310	717	330	0.91	0.34	0.081	500		
146						2000		3600	699	320	0.92	0.34	0.081	500		
87	1230							2210	675	383	0.87	0.25	0.064	700	10	
129		1890						3400	650	365	0.88	0.25	0.064	700		
139			1990					3580	668	365	0.91	0.25	0.064	700		
145				2080				3600	663	360	0.91	0.25	0.064	700		
149					2180			3600	654	355	0.91	0.25	0.064	700		
158						2370		3600	637	345	0.92	0.25	0.064	700		
188							2840	3600	631	340	0.92	0.25	0.064	700		

1. Higher speed ranges by field weakening can be studied according to the application : consult us.

P : Rated power  
M : Rated moment  
I : Permissible current in continuous operation  
 $\eta$  : Efficiency  
L : Motor self-induction coil  
R : Armature resistance at 115°C  
 $U_{max}$  : Maximum armature voltage

# Open continuous current (DC) motors LSK 2004 M

## Selection

**IP 23S motor - IC 06 ventilation - Class H**  
**Full bridge three-phase power supply**  
**S1 duty - Ambient temperature  $\leq 40^{\circ}\text{C}$  - Total weight: 630 kg - Inertia moment: 1.3 kg.m<sup>2</sup>**  
**Excitation power: 2.4 kW - Maximum mechanical speed: 3200 min<sup>-1</sup>**

P	Rotation speed $n$ for armature voltage $U$							$n_{max}$	M	I	$\eta$	L	$R_{115^{\circ}}$	$U_{max}$	Index	Qty
	260 V min <sup>-1</sup>	400 V min <sup>-1</sup>	420 V min <sup>-1</sup>	440 V min <sup>-1</sup>	460 V min <sup>-1</sup>	500 V min <sup>-1</sup>	600 V min <sup>-1</sup>									
20.8	270							340	736	111	0.72	17.7	0.637	750	03	
36.1		420						525	821	111	0.81	17.7	0.637	750		
38.2			440					550	829	111	0.82	17.7	0.637	750		
40.4				460				575	839	111	0.83	17.7	0.637	750		
42.6					480			600	848	111	0.84	17.7	0.637	750		
47						520		650	863	111	0.85	17.7	0.637	750		
56.6							620	775	872	111	0.85	8.8	0.637	750		
32.2	390							500	788	155	0.80	8.8	0.33	550	04	
53.4		600						750	850	155	0.86	8.8	0.33	550		
56.2			630					790	852	155	0.86	8.8	0.33	550		
59				660				825	854	155	0.87	8.8	0.33	550		
62					690			860	858	155	0.87	8.8	0.33	550		
67.6						750		940	861	155	0.87	8.8	0.33	550		
38	430							740	844	180	0.81	6.5	0.25	500		05
62.6		710						1150	842	180	0.87	6.5	0.25	500		
66.5			750					1200	847	180	0.88	6.5	0.25	500		
69.9				790				1250	845	180	0.88	6.5	0.25	500		
73.2					830			1300	842	180	0.88	6.5	0.25	500		
80.2						910		1450	842	180	0.89	6.5	0.25	500		
49.3	570							750	826	224	0.85	4.2	0.16	750	06	
79.9		880						1100	867	224	0.89	4.2	0.16	750		
83.9			920					1150	871	224	0.89	4.2	0.16	750		
87.9				960				1200	874	224	0.89	4.2	0.16	750		
92.9					1010			1270	878	224	0.90	4.2	0.16	750		
102						1100		1375	883	224	0.91	4.2	0.16	750		
122							1320	1600	885	224	0.91	4.2	0.16	750		
71.5	790							1000	864	310	0.89	2.2	0.081	550	07	
113		1220						1500	886	310	0.91	2.2	0.081	550		
119			1280					1550	889	310	0.92	2.2	0.081	550		
125				1340				1650	892	310	0.92	2.2	0.081	550		
131					1400			1700	895	310	0.92	2.2	0.081	550		
143						1520		1830	899	310	0.92	2.2	0.081	550		

1. Higher speed ranges by field weakening can be studied according to the application : consult us.

P : Rated power  
M : Rated moment  
I : Permissible current in continuous operation  
 $\eta$  : Efficiency  
L : Motor self-induction coil  
R : Armature resistance at 115°C  
 $U_{max}$  : Maximum armature voltage



# Open continuous current (DC) motors LSK 2004 M

## Selection

IP 23S motor - IC 06 ventilation - Class H  
Full bridge three-phase power supply  
S1 duty - Ambient temperature  $\leq 40^{\circ}\text{C}$  - Total weight: 630 kg - Inertia moment: 1.3 kg.m<sup>2</sup>  
Excitation power: 2.4 kW - Maximum mechanical speed: 3200 min<sup>-1</sup>

P	Rotation speed $n$ for armature voltage $U$							$n_{max}$	M	I	$\eta$	L	$R_{115^{\circ}}$	$U_{max}$	Index	Qty
	260 V min <sup>-1</sup>	400 V min <sup>-1</sup>	420 V min <sup>-1</sup>	440 V min <sup>-1</sup>	460 V min <sup>-1</sup>	500 V min <sup>-1</sup>	600 V min <sup>-1</sup>									
83.9	940							1500	852	363	0.89	1.55	0.063	500	08	1
133		1490						2200	852	363	0.92	1.55	0.063	500		
140			1570					2250	852	363	0.92	1.55	0.063	500		
147				1650				2300	851	363	0.92	1.55	0.063	500		
154					1730			2350	851	363	0.92	1.55	0.063	500		
168						1885		2500	852	363	0.93	1.55	0.063	500		
93.6	1130							1400	791	400	0.90	1.25	0.048	750	10	
148		1740						2100	810	400	0.92	1.25	0.048	750		
151			1830					2200	789	390	0.92	1.25	0.048	750		
153				1910				2300	763	375	0.93	1.25	0.048	750		
156					2000			2400	743	365	0.93	1.25	0.048	750		
162						2170		2600	714	350	0.93	1.25	0.048	750		
184							2610	3000	674	330	0.93	1.25	0.048	750	11	
102	1560							1900	624	430	0.91	0.85	0.03	650		
155		2400						2800	615	420	0.92	0.85	0.03	650		
160			2520					2900	606	410	0.93	0.85	0.03	650		
163				2640				3000	591	400	0.93	0.85	0.03	650		
171					2865			3200	569	400	0.93	0.85	0.03	650		

1. Higher speed ranges by field weakening can be studied according to the application : consult us.

P : Rated power  
M : Rated moment  
I : Permissible current in continuous operation  
 $\eta$  : Efficiency  
L : Motor self-induction coil  
R : Armature resistance at 115°C  
 $U_{max}$  : Maximum armature voltage

# Open continuous current (DC) motors LSK 2004 L

## Selection

**IP 23S motor - IC 06 ventilation - Class H**  
**Full bridge three-phase power supply**  
**S1 duty - Ambient temperature  $\leq 40^{\circ}\text{C}$  - Total weight: 710 kg - Inertia moment: 1.5 kg.m<sup>2</sup>**  
**Excitation power: 2.7 kW - Maximum mechanical speed: 3200 min<sup>-1</sup>**

P	Rotation speed $n$ for armature voltage $U$							$n_{max}$	M	I	$\eta$	L	$R_{115^{\circ}}$	$U_{max}$	Index	Qty
	260 V min <sup>-1</sup>	400 V min <sup>-1</sup>	420 V min <sup>-1</sup>	440 V min <sup>-1</sup>	460 V min <sup>-1</sup>	500 V min <sup>-1</sup>	600 V min <sup>-1</sup>									
20.1	225							280	853	111	0.70	21.4	0.702	750	03	
35.4		350						440	966	111	0.80	21.4	0.702	750		
37.5			360					450	995	111	0.81	21.4	0.702	750		
39.8				380				480	1000	111	0.81	21.4	0.702	750		
42					400			500	1003	111	0.82	21.4	0.702	750		
46.3						430		540	1028	111	0.84	21.4	0.702	750		
55.6							520	650	1021	111	0.84	21.4	0.702	750		
31.8	330							410	920	155	0.79	10.4	0.36	550	04	
53		510						640	992	155	0.86	10.4	0.36	550		
56			530					660	1009	155	0.86	10.4	0.36	550		
59.2				560				700	1010	155	0.87	10.4	0.36	550		
62.2					580			725	1024	155	0.87	10.4	0.36	550		
68.1						630		790	1032	155	0.88	10.4	0.36	550		
37.3	385							480	925	180	0.80	7.7	0.276	500		05
62		590						740	1004	180	0.86	7.7	0.276	500		
65.4			620					780	1007	180	0.87	7.7	0.276	500		
69.1				650				810	1015	180	0.87	7.7	0.276	500		
72.6					680			850	1020	180	0.88	7.7	0.276	500		
79.6						740		925	1027	180	0.88	7.7	0.276	500		
48.6	455							590	1020	224	0.84	5	0.175	750	06	
79.4		745						870	1018	224	0.89	5	0.175	750		
83.7			790					910	1012	224	0.89	5	0.175	750		
88.1				830				960	1014	224	0.89	5	0.175	750		
92.4					870			1000	1014	224	0.90	5	0.175	750		
101						955		1080	1011	224	0.90	5	0.175	750		
121							1160	1300	999	224	0.90	5	0.175	750		
70.5	670							840	1005	310	0.88	2.6	0.09	550	07	
113		1030						1250	1046	310	0.91	2.6	0.09	550		
119			1080					1300	1051	310	0.91	2.6	0.09	550		
125				1130				1350	1055	310	0.92	2.6	0.09	550		
131					1190			1430	1050	310	0.92	2.6	0.09	550		
143						1290		1550	1057	310	0.92	2.6	0.09	550		

1. Higher speed ranges by field weakening can be studied according to the application : consult us.

P : Rated power  
M : Rated moment  
I : Permissible current in continuous operation  
 $\eta$  : Efficiency  
L : Motor self-induction coil  
R : Armature resistance at 115°C  
 $U_{max}$  : Maximum armature voltage

# Open continuous current (DC) motors LSK 2004 L

## Selection

**IP 23S motor - IC 06 ventilation - Class H**  
**Full bridge three-phase power supply**  
**S1 duty - Ambient temperature  $\leq 40^{\circ}\text{C}$  - Total weight: 710 kg - Inertia moment: 1.5 kg.m<sup>2</sup>**  
**Excitation power: 2.7 kW - Maximum mechanical speed: 3200 min<sup>-1</sup>**

P	Rotation speed $n$ for armature voltage $U$							$n_{max}$	M	I	$\eta$	L	$R_{115^{\circ}}$	$U_{max}$	Index	Qty
	260 V min <sup>-1</sup>	400 V min <sup>-1</sup>	420 V min <sup>-1</sup>	440 V min <sup>-1</sup>	460 V min <sup>-1</sup>	500 V min <sup>-1</sup>	600 V min <sup>-1</sup>									
83.3	785							1200	1013	363	0.88	1.85	0.07	500	08	
133		1255						1800	1010	363	0.91	1.85	0.07	500		
140			1325					1900	1007	363	0.92	1.85	0.07	500		
147				1390				2000	1007	363	0.92	1.85	0.07	500		
154					1455			2100	1008	363	0.92	1.85	0.07	500		
168						1590		2250	1007	363	0.92	1.85	0.07	500		
95.8	910							1090	1005	412	0.89	1.45	0.053	750	10	
152		1400						1680	1034	412	0.92	1.45	0.053	750		
160			1470					1765	1036	412	0.92	1.45	0.053	750		
167				1540				1850	1034	410	0.92	1.45	0.053	750		
173					1610			1930	1029	407	0.93	1.45	0.053	750		1
184						1750		2100	1001	395	0.93	1.45	0.053	750		
209							2100	2500	949	374	0.93	1.45	0.053	750		
119	1210							1450	942	505	0.91	0.95	0.033	650	11	
187		1860						2230	960	503	0.93	0.95	0.033	650		
188			1950					2350	921	481	0.93	0.95	0.033	650		
189				2050				2500	880	462	0.93	0.95	0.033	650		
190					2140			2600	848	444	0.93	0.95	0.033	650		
196						2330		2700	802	420	0.93	0.95	0.033	650		
220							2790	3200	752	393	0.93	0.95	0.033	650		

1. Higher speed ranges by field weakening can be studied according to the application : consult us.

$P$  : Rated power  
 $M$  : Rated moment  
 $I$  : Permissible current in continuous operation  
 $\eta$  : Efficiency  
 $L$  : Motor self-induction coil  
 $R$  : Armature resistance at 115°C  
 $U_{max}$  : Maximum armature voltage

# Open continuous current (DC) motors LSK 2254 M

## Selection

IP 23S motor - IC 06 ventilation - Class H  
Full bridge three-phase power supply  
S1 duty - Ambient temperature  $\leq 40^{\circ}\text{C}$  - Total weight: 810 kg - Inertia moment: 2.2 kg.m<sup>2</sup>  
Excitation power: 2.7 kW - Maximum mechanical speed: 3000 min<sup>-1</sup>

P	Rotation speed $n$ for armature voltage $U$							$n_{max}$	M	I	$\eta$	L	$R_{115^{\circ}}$	$U_{max}$	Index	Qty
	260 V min <sup>-1</sup>	400 V min <sup>-1</sup>	420 V min <sup>-1</sup>	440 V min <sup>-1</sup>	460 V min <sup>-1</sup>	500 V min <sup>-1</sup>	600 V min <sup>-1</sup>									
43.3	400							600	1034	205	0.81	6	0.187	650	07	
71		655						900	1035	205	0.87	6	0.187	650		
74.7			690					950	1034	205	0.87	6	0.187	650		
79.1				730				1000	1035	205	0.88	6	0.187	650		
82.9					765			1050	1035	205	0.88	6	0.187	650		
91						840		1150	1035	205	0.88	6	0.187	650		
112							1030	1400	1035	205	0.89	6	0.187	650		
61.6	560							1200	1051	275	0.86	3.3	0.102	650	08	
100		900						1900	1061	275	0.90	3.3	0.102	650		
104			950					1950	1049	275	0.90	3.3	0.102	650		
110				1000				2000	1051	275	0.91	3.3	0.102	650		
116					1050			2050	1051	275	0.91	3.3	0.102	650		
125						1140		2150	1050	275	0.91	3.3	0.102	650		
151							1390	2400	1035	275	0.91	3.3	0.102	650		
85.7	790							1100	1036	365	0.90	1.85	0.053	500	09	
135		1220						1650	1059	365	0.93	1.85	0.053	500		
142			1280					1750	1062	365	0.93	1.85	0.053	500		
150				1340				1800	1065	365	0.93	1.85	0.053	500		
157					1400			1900	1069	365	0.93	1.85	0.053	500		
171						1520		2050	1072	365	0.94	1.85	0.053	500		
105	970							1350	1029	438	0.92	1.25	0.034	750		10
164		1490						2000	1051	438	0.94	1.25	0.034	750		
172			1570					2100	1049	438	0.94	1.25	0.034	750		
181				1640				2200	1053	438	0.94	1.25	0.034	750		
186					1720			2300	1031	430	0.94	1.25	0.034	750		
200						1870		2400	1020	425	0.94	1.25	0.034	750		
234							2240	2800	996	414	0.94	1.25	0.034	750		

1. Higher speed ranges by field weakening can be studied according to the application : consult us.

P : Rated power  
M : Rated moment  
I : Permissible current in continuous operation  
 $\eta$  : Efficiency  
L : Motor self-induction coil  
R : Armature resistance at 115°C  
 $U_{max}$  : Maximum armature voltage

# Open continuous current (DC) motors LSK 2254 M

## Selection

IP 23S motor - IC 06 ventilation - Class H  
Full bridge three-phase power supply  
S1 duty - Ambient temperature  $\leq 40^{\circ}\text{C}$  - Total weight: 810 kg - Inertia moment: 2.2 kg.m<sup>2</sup>  
Excitation power: 2.7 kW - Maximum mechanical speed: 3000 min<sup>-1</sup>

P	Rotation speed $n$ for armature voltage $U$							$n_{max}$	M	I	$\eta$	L	$R_{115^{\circ}}$	$U_{max}$	Index	Qty
	260 V min <sup>-1</sup>	400 V min <sup>-1</sup>	420 V min <sup>-1</sup>	440 V min <sup>-1</sup>	460 V min <sup>-1</sup>	500 V min <sup>-1</sup>	600 V min <sup>-1</sup>									
120	1140							1500	1006	500	0.92	1	0.026	700	11	
188		1750						2300	1024	500	0.94	1	0.026	700		
197			1840					2350	1024	500	0.94	1	0.026	700		
198				1930				2500	981	480	0.94	1	0.026	700		
203					2020			2600	961	470	0.94	1	0.026	700		
216						2280		2800	906	460	0.94	1	0.026	700		
251							2740	3000	875	445	0.94	1	0.026	700		
130	1260							1650	983	540	0.92	0.85	0.023	650	12	
195		1940						2500	960	520	0.94	0.85	0.023	650		
201			2040					2550	941	510	0.94	0.85	0.023	650		
207				2130				2600	926	500	0.94	0.85	0.023	650		
213					2230			2800	912	493	0.94	0.85	0.023	650		
227						2540		3000	854	484	0.94	0.85	0.023	650		
141	1410							1850	956	584	0.93	0.7	0.019	600	13	
216		2170						2700	947	575	0.94	0.7	0.019	600		
217			2280					2800	909	550	0.94	0.7	0.019	600		
219				2390				2900	875	529	0.94	0.7	0.019	600		
223					2540			3000	839	516	0.94	0.7	0.019	600		
236						2880		3000	784	503	0.94	0.7	0.019	600		
155	1550							2050	954	640	0.93	0.6	0.017	550	14	
225		2380						2900	903	600	0.94	0.6	0.017	550		
223			2500					3000	853	567	0.94	0.6	0.017	550		
227				2620				3000	827	550	0.94	0.6	0.017	550		
232					2750			3000	806	537	0.94	0.6	0.017	550		

1. Higher speed ranges by field weakening can be studied according to the application : consult us.

P : Rated power  
M : Rated moment  
I : Permissible current in continuous operation  
 $\eta$  : Efficiency  
L : Motor self-induction coil  
R : Armature resistance at 115°C  
 $U_{max}$  : Maximum armature voltage

# Open continuous current (DC) motors LSK 2254 L

## Selection

IP 23S motor - IC 06 ventilation - Class H  
Full bridge three-phase power supply  
S1 duty - Ambient temperature  $\leq 40^{\circ}\text{C}$  - Total weight: 920 kg - Inertia moment: 2.4 kg.m<sup>2</sup>  
Excitation power: 3.2 kW - Maximum mechanical speed: 3000 min<sup>-1</sup>

P	Rotation speed $n$ for armature voltage $U$							$n_{max}$	M	I	$\eta$	L	$R_{115^{\circ}}$	$U_{max}$	Index	Qty
	260 V min <sup>-1</sup>	400 V min <sup>-1</sup>	420 V min <sup>-1</sup>	440 V min <sup>-1</sup>	460 V min <sup>-1</sup>	500 V min <sup>-1</sup>	600 V min <sup>-1</sup>									
47.2	320							450	1409	225	0.83	6.85	0.215	650	07	
75.5		525						700	1373	225	0.86	6.85	0.215	650		
82			555					750	1411	225	0.87	6.85	0.215	650		
86.4				585				800	1410	225	0.88	6.85	0.215	650		
91.5					620			850	1409	225	0.89	6.85	0.215	650		
99.6						675		950	1409	225	0.89	6.85	0.215	650		
122							825	1200	1412	225	0.90	6.85	0.215	650		
66.7	445							1000	1431	300	0.86	3.75	0.117	650	08	
108		720						1500	1433	300	0.90	3.75	0.117	650		
114			760					1550	1433	300	0.91	3.75	0.117	650		
120				800				1600	1433	300	0.91	3.75	0.117	650		
126					840			1700	1433	300	0.91	3.75	0.117	650		
138						920		1800	1433	300	0.92	3.75	0.117	650		
166							1250	2200	1415	300	0.92	3.75	0.117	650		
91.1	650							900	1338	394	0.89	2.1	0.061	500	09	
143		1000						1350	1362	394	0.91	2.1	0.061	500		
152			1050					1450	1384	394	0.92	2.1	0.061	500		
160				1100				1500	1389	394	0.92	2.1	0.061	500		
168					1150			1550	1392	394	0.93	2.1	0.061	500		
183						1250		1700	1395	394	0.93	2.1	0.061	500		
112	790							1100	1355	475	0.91	1.4	0.039	750		10
177		1220						1650	1385	475	0.93	1.4	0.039	750		
186			1280					1750	1388	475	0.93	1.4	0.039	750		
195				1340				1800	1393	475	0.94	1.4	0.039	750		
205					1400			1900	1395	475	0.94	1.4	0.039	750		
223						1520		2050	1401	475	0.94	1.4	0.039	750		
268							1820	2450	1406	475	0.94	1.4	0.039	750		

1. Higher speed ranges by field weakening can be studied according to the application : consult us.

P : Rated power  
M : Rated moment  
I : Permissible current in continuous operation  
 $\eta$  : Efficiency  
L : Motor self-induction coil  
R : Armature resistance at 115°C  
 $U_{max}$  : Maximum armature voltage

# Open continuous current (DC) motors LSK 2254 L

## Selection

**IP 23S motor - IC 06 ventilation - Class H**  
**Full bridge three-phase power supply**  
**S1 duty - Ambient temperature  $\leq 40^{\circ}\text{C}$  - Total weight: 920 kg - Inertia moment: 2.4 kg.m<sup>2</sup>**  
**Excitation power: 3.2 kW - Maximum mechanical speed: 3000 min<sup>-1</sup>**

P	Rotation speed $n$ for armature voltage $U$							$n_{max}$	M	I	$\eta$	L	$R_{115^{\circ}}$	$U_{max}$	Index	Qty
	260 V min <sup>-1</sup>	400 V min <sup>-1</sup>	420 V min <sup>-1</sup>	440 V min <sup>-1</sup>	460 V min <sup>-1</sup>	500 V min <sup>-1</sup>	600 V min <sup>-1</sup>									
129	900							1200	1364	540	0.92	1.1	0.03	700	11	1
202		1380						1800	1398	540	0.94	1.1	0.03	700		
212			1450					1900	1398	540	0.94	1.1	0.03	700		
223				1520				2000	1400	540	0.94	1.1	0.03	700		
233					1590			2100	1401	540	0.94	1.1	0.03	700		
254						1750		2300	1387	540	0.94	1.1	0.03	700		
294							2100	2750	1335	520	0.94	1.1	0.03	700		
139	970							1300	1367	582	0.92	0.95	0.027	650	12	
218		1490						1950	1395	582	0.94	0.95	0.027	650		
227			1570					2050	1378	575	0.94	0.95	0.027	650		
237				1640				2150	1378	573	0.94	0.95	0.027	650		
247					1720			2250	1369	571	0.94	0.95	0.027	650		
265						1930		2400	1311	563	0.94	0.95	0.027	650		
308							2320	2800	1269	546	0.94	0.95	0.027	650		
152	1075							1400	1349	633	0.92	0.8	0.022	600	13	
238		1650						2150	1376	633	0.94	0.8	0.022	600		
250			1740					2250	1372	633	0.94	0.8	0.022	600		
257				1820				2300	1347	620	0.94	0.8	0.022	600		
262					1930			2400	1295	604	0.94	0.8	0.022	600		
280						2150		2700	1242	593	0.94	0.8	0.022	600		
324							2600	3000	1189	572	0.94	0.8	0.022	600		
167	1180							1600	1348	693	0.92	0.66	0.019	550	14	1
254		1820						2300	1330	675	0.94	0.66	0.019	550		
261			1910					2400	1303	660	0.94	0.66	0.019	550		
269				2050				2600	1254	650	0.94	0.66	0.019	550		
276					2170			2700	1215	637	0.94	0.66	0.019	550		
294						2440		2900	1150	624	0.94	0.66	0.019	550		

1. Higher speed ranges by field weakening can be studied according to the application : consult us.

P : Rated power  
M : Rated moment  
I : Permissible current in continuous operation  
 $\eta$  : Efficiency  
L : Motor self-induction coil  
R : Armature resistance at 115°C  
 $U_{max}$  : Maximum armature voltage

# Open continuous current (DC) motors LSK 2254 VL

## Selection

**IP 23S motor - IC 06 ventilation - Class H**  
**Full bridge three-phase power supply**  
**S1 duty - Ambient temperature  $\leq 40^{\circ}\text{C}$  - Total weight: 1000 kg - Inertia moment: 2.7 kg.m<sup>2</sup>**  
**Excitation power: 3.2 kW - Maximum mechanical speed: 3000 min<sup>-1</sup>**

P	Rotation speed $n$ for armature voltage $U$							$n_{max}$	M	I	$\eta$	L	$R_{115^{\circ}}$	$U_{max}$	Index	Qty
	260 V min <sup>-1</sup>	400 V min <sup>-1</sup>	420 V min <sup>-1</sup>	440 V min <sup>-1</sup>	460 V min <sup>-1</sup>	500 V min <sup>-1</sup>	600 V min <sup>-1</sup>									
48.7	300							400	1549	225	0.83	7.5	0.212	650	07	
75.9		480						650	1510	225	0.84	7.5	0.212	650		
81.3			500					675	1552	225	0.86	7.5	0.212	650		
86				530				700	1550	225	0.87	7.5	0.212	650		
90.8					560			750	1549	225	0.88	7.5	0.212	650		
98.9						610		850	1549	225	0.88	7.5	0.212	650		
121.9							750	1050	1552	225	0.90	7.5	0.212	650		
65.9	400							550	1573	300	0.84	4.13	0.116	650	08	
107		650						900	1575	300	0.89	4.13	0.116	650		
114			690					950	1575	300	0.90	4.13	0.116	650		
119				720				1000	1575	300	0.90	4.13	0.116	650		
125					760			1050	1575	300	0.91	4.13	0.116	650		
137						830		1150	1575	300	0.91	4.13	0.116	650		
166							1020	1400	1555	300	0.92	4.13	0.116	650		
90.9	590							800	1471	395	0.88	2.28	0.068	500	09	
141		900						1250	1498	395	0.89	2.28	0.068	500		
151			950					1300	1522	395	0.91	2.28	0.068	500		
158				990				1350	1527	395	0.91	2.28	0.068	500		
168					1050			1450	1531	395	0.93	2.28	0.068	500		
185						1150		1600	1534	395	0.94	2.28	0.068	500		
111	710							1000	1490	475	0.90	1.55	0.049	750		10
175		1100						1475	1523	475	0.92	1.55	0.049	750		
184			1150					1550	1526	475	0.92	1.55	0.049	750		
194				1210				1600	1531	475	0.93	1.55	0.049	750		
202					1260			1700	1534	475	0.93	1.55	0.049	750		
221						1370		1850	1540	475	0.93	1.55	0.049	750		
267							1650	2200	1546	475	0.94	1.55	0.049	750		

1. Higher speed ranges by field weakening can be studied according to the application : consult us.

P : Rated power  
M : Rated moment  
I : Permissible current in continuous operation  
 $\eta$  : Efficiency  
L : Motor self-induction coil  
R : Armature resistance at 115°C  
 $U_{max}$  : Maximum armature voltage



# Open continuous current (DC) motors LSK 2254 VL

## Selection

IP 23S motor - IC 06 ventilation - Class H  
Full bridge three-phase power supply  
S1 duty - Ambient temperature  $\leq 40^{\circ}\text{C}$  - Total weight: 1000 kg - Inertia moment: 2.7 kg.m<sup>2</sup>  
Excitation power: 3.2 kW - Maximum mechanical speed: 3000 min<sup>-1</sup>

P	Rotation speed $n$ for armature voltage $U$							$n_{max}$	M	I	$\eta$	L	$R_{115^{\circ}}$	$U_{max}$	Index	Qty	
	260 V min <sup>-1</sup>	400 V min <sup>-1</sup>	420 V min <sup>-1</sup>	440 V min <sup>-1</sup>	460 V min <sup>-1</sup>	500 V min <sup>-1</sup>	600 V min <sup>-1</sup>										Elec <sup>1</sup> min <sup>-1</sup>
127	810							1100	1500	540	0.91	1.2	0.038	700	11		
200		1240						1675	1537	540	0.92	1.2	0.038	700			
211			1310					1750	1537	540	0.93	1.2	0.038	700			
221				1370				1850	1539	540	0.93	1.2	0.038	700			
232					1440			1950	1540	540	0.93	1.2	0.038	700			
251						1570		2100	1525	540	0.93	1.2	0.038	700			
292							1900	2500	1468	520	0.94	1.2	0.038	700			
138	870							1250	1510	585	0.90	1.03	0.031	650		12	
216		1340						1800	1541	585	0.92	1.03	0.031	650			
224			1410					1900	1520	575	0.93	1.03	0.031	650			
239				1500				2000	1520	575	0.94	1.03	0.031	650			
248					1560			2100	1520	575	0.94	1.03	0.031	650			
265						1750		2300	1446	565	0.94	1.03	0.031	650			
309							2100	2600	1406	550	0.94	1.03	0.031	650			
150	965							1300	1488	635	0.91	0.88	0.029	600	13		
235		1480						1900	1517	635	0.93	0.88	0.029	600			
247			1560					2000	1513	635	0.93	0.88	0.029	600			
254				1640				2150	1481	620	0.93	0.88	0.029	600			
260					1740			2250	1425	605	0.93	0.88	0.029	600			
278						1940		2500	1370	595	0.94	0.88	0.029	600			
323							2350	2800	1314	575	0.94	0.88	0.029	600			
166	1060							1400	1498	695	0.92	0.72	0.024	550	14	1	
253		1640						2150	1475	675	0.94	0.72	0.024	550			
263			1720					2250	1460	670	0.93	0.72	0.024	550			
273				1850				2400	1410	665	0.93	0.72	0.024	550			
281					1960			2500	1370	650	0.94	0.72	0.024	550			
298						2200		2700	1295	635	0.94	0.72	0.024	550			

1. Higher speed ranges by field weakening can be studied according to the application : consult us.

P : Rated power  
M : Rated moment  
I : Permissible current in continuous operation  
 $\eta$  : Efficiency  
L : Motor self-induction coil  
R : Armature resistance at 115°C  
 $U_{max}$  : Maximum armature voltage

# Open continuous current (DC) motors LSK 2504C M

## Selection

IP 23S motor - IC 06 ventilation - Class H  
Full bridge three-phase power supply  
S1 duty - Ambient temperature  $\leq 40^{\circ}\text{C}$  - Total weight: 1400 kg - Inertia moment: 4.1 kg.m<sup>2</sup>  
Excitation power: 3 kW - Maximum mechanical speed: 2100 min<sup>-1</sup>

P	Rotation speed $n$ for armature voltage $U$							$n_{max}$	M	I	$\eta$	L	$R_{115^{\circ}}$	$U_{max}$	Index	Qty
	260 V min <sup>-1</sup>	400 V min <sup>-1</sup>	420 V min <sup>-1</sup>	440 V min <sup>-1</sup>	460 V min <sup>-1</sup>	500 V min <sup>-1</sup>	600 V min <sup>-1</sup>									
51	310							430	1571	260	0.75	1.85	0.25	650	0A	
86		510						710	1610	260	0.83	1.85	0.25	650		
92			540					760	1627	260	0.84	1.85	0.25	650		
97				570				800	1625	260	0.85	1.85	0.25	650		
103					610			840	1613	260	0.86	1.85	0.25	650		
113						660		910	1635	260	0.87	1.85	0.25	650		
136							810	1090	1603	260	0.87	1.85	0.25	650		
88	530							740	1586	400	0.85	0.74	0.092	650	0B	
142		870						1220	1559	400	0.89	0.74	0.092	650		
151			910					1270	1585	400	0.90	0.74	0.092	650		
158				960				1340	1572	400	0.90	0.74	0.092	650		
167					1010			1400	1579	400	0.91	0.74	0.092	650		
182						1100		1520	1580	400	0.91	0.74	0.092	650		
221							1320	1830	1599	400	0.92	0.74	0.092	650		
139	780							1090	1702	600	0.89	0.38	0.044	750	01	
218		1200						1680	1735	600	0.91	0.38	0.044	750		
232			1260					1760	1758	600	0.92	0.38	0.044	750		
243				1320				1850	1758	600	0.92	0.38	0.044	750		
257					1380			1930	1779	600	0.93	0.38	0.044	750		
279						1500		2100	1776	600	0.93	0.38	0.044	750		
335							1800	2100	1777	600	0.93	0.38	0.044	750		

1. Higher speed ranges by field weakening can be studied according to the application : consult us.

P : Rated power  
M : Rated moment  
I : Permissible current in continuous operation  
 $\eta$  : Efficiency  
L : Motor self-induction coil  
R : Armature resistance at 115°C  
 $U_{max}$  : Maximum armature voltage

# Open continuous current (DC) motors LSK 2504C M

## Selection

IP 23S motor - IC 06 ventilation - Class H  
Full bridge three-phase power supply  
S1 duty - Ambient temperature  $\leq 40^{\circ}\text{C}$  - Total weight: 1400 kg - Inertia moment: 4.1 kg.m<sup>2</sup>  
Excitation power: 3 kW - Maximum mechanical speed: 2100 min<sup>-1</sup>

P	Rotation speed $n$ for armature voltage $U$							$n_{max}$	M	I	$\eta$	L	$R_{115^{\circ}}$	$U_{max}$	Index	Qty
	260 V min <sup>-1</sup>	400 V min <sup>-1</sup>	420 V min <sup>-1</sup>	440 V min <sup>-1</sup>	460 V min <sup>-1</sup>	500 V min <sup>-1</sup>	600 V min <sup>-1</sup>									
161	910							1270	1690	690	0.90	0.28	0.034	550	02	
251		1400						1960	1712	690	0.91	0.28	0.034	550		
267			1470					2060	1735	690	0.92	0.28	0.034	550		
282				1540				2100	1749	690	0.93	0.28	0.034	550		
295					1610			2100	1750	690	0.93	0.28	0.034	550		
321						1750		2100	1752	690	0.93	0.28	0.034	550		
189	1110							1540	1626	800	0.91	0.2	0.023	550	03	1
294		1710						2100	1642	800	0.92	0.2	0.023	550		
312			1790					2100	1665	800	0.93	0.2	0.023	550		
319				1880				2100	1620	800	0.93	0.2	0.023	550		
333					1960			2100	1623	800	0.94	0.2	0.023	550		
208	1200							1680	1655	870	0.92	0.17	0.0184	500	04	
324		1850						2100	1673	870	0.93	0.17	0.0184	500		
340			1940					2100	1674	860	0.94	0.17	0.0184	500		
343				2080				2100	1575	830	0.94	0.17	0.0184	500		
227	1360							1900	1594	950	0.92	0.13	0.015	500	06	

1. Higher speed ranges by field weakening can be studied according to the application : consult us.

P : Rated power  
M : Rated moment  
I : Permissible current in continuous operation  
 $\eta$  : Efficiency  
L : Motor self-induction coil  
R : Armature resistance at 115°C  
 $U_{max}$  : Maximum armature voltage

# Open continuous current (DC) motors LSK 2504C L

## Selection

IP 23S motor - IC 06 ventilation - Class H  
Full bridge three-phase power supply  
S1 duty - Ambient temperature  $\leq 40^{\circ}\text{C}$  - Total weight: 1500 kg - Inertia moment: 4.6 kg.m<sup>2</sup>  
Excitation power: 3 kW - Maximum mechanical speed: 2100 min<sup>-1</sup>

P	Rotation speed $n$ for armature voltage $U$							$n_{max}$	M	I	$\eta$	L	$R_{115^{\circ}}$	$U_{max}$	Index	Qty
	260 V min <sup>-1</sup>	400 V min <sup>-1</sup>	420 V min <sup>-1</sup>	440 V min <sup>-1</sup>	460 V min <sup>-1</sup>	500 V min <sup>-1</sup>	600 V min <sup>-1</sup>									
51	260							360	1873	260	0.75	2.2	0.27	650	0A	
86		430						600	1910	260	0.83	2.2	0.27	650		
92			450					630	1952	260	0.84	2.2	0.27	650		
97				480				670	1930	260	0.85	2.2	0.27	650		
103					510			710	1929	260	0.86	2.2	0.27	650		
113						560		760	1927	260	0.87	2.2	0.27	650		
136							690	920	1882	260	0.87	2.2	0.27	650		
88	450							630	1868	400	0.85	0.88	0.1	650	0B	
142		730						1020	1858	400	0.89	0.88	0.1	650		
151			770					1080	1873	400	0.90	0.88	0.1	650		
158				810				1130	1863	400	0.90	0.88	0.1	650		
167					850			1180	1876	400	0.91	0.88	0.1	650		
182						930		1280	1869	400	0.91	0.88	0.1	650		
221							1120	1540	1884	400	0.92	0.88	0.1	650		
139	660							920	2011	600	0.89	0.44	0.048	750	01	
218		1020						1430	2041	600	0.91	0.44	0.048	750		
232			1070					1500	2071	600	0.92	0.44	0.048	750		
243				1120				1570	2072	600	0.92	0.44	0.048	750		
257					1170			1640	2098	600	0.93	0.44	0.048	750		
279						1270		1780	2098	600	0.93	0.44	0.048	750		
335							1520	2100	2105	600	0.93	0.44	0.048	750		

1. Higher speed ranges by field weakening can be studied according to the application : consult us.

P : Rated power  
M : Rated moment  
I : Permissible current in continuous operation  
 $\eta$  : Efficiency  
L : Motor self-induction coil  
R : Armature resistance at 115°C  
 $U_{max}$  : Maximum armature voltage

# Open continuous current (DC) motors LSK 2504C L

## Selection

IP 23S motor - IC 06 ventilation - Class H  
Full bridge three-phase power supply  
S1 duty - Ambient temperature  $\leq 40^{\circ}\text{C}$  - Total weight: 1500 kg - Inertia moment: 4.6 kg.m<sup>2</sup>  
Excitation power: 3 kW - Maximum mechanical speed: 2100 min<sup>-1</sup>

P	Rotation speed $n$ for armature voltage $U$							$n_{max}$	M	I	$\eta$	L	$R_{115^{\circ}}$	$U_{max}$	Index	Qty
	260 V min <sup>-1</sup>	400 V min <sup>-1</sup>	420 V min <sup>-1</sup>	440 V min <sup>-1</sup>	460 V min <sup>-1</sup>	500 V min <sup>-1</sup>	600 V min <sup>-1</sup>									
161	770							1080	1997	690	0.90	0.33	0.038	550	02	
251		1180						1650	2031	690	0.91	0.33	0.038	550		
267			1240					1740	2056	690	0.92	0.33	0.038	550		
282				1300				1820	2072	690	0.93	0.33	0.038	550		
295					1360			1900	2072	690	0.93	0.33	0.038	550		
321						1480		2100	2071	690	0.93	0.33	0.038	550		
189	920							1080	1962	800	0.91	0.23	0.025	550	03	1
294		1420						1650	1977	800	0.92	0.23	0.025	550		
312			1490					1740	2000	800	0.93	0.23	0.025	550		
327				1560				1820	2002	800	0.93	0.23	0.025	550		
342					1630			1900	2004	800	0.93	0.23	0.025	550		
376						1770		2070	2029	800	0.94	0.23	0.025	550		
208	1020							1430	1947	870	0.92	0.17	0.0184	500	04	
324		1570						2100	1971	870	0.93	0.17	0.0184	500		
340			1650					2100	1968	870	0.93	0.17	0.0184	500		
360				1730				2100	1987	870	0.94	0.17	0.0184	500		
376					1800			2100	1995	870	0.94	0.17	0.0184	500		
409						1960		2100	1993	870	0.94	0.17	0.0184	500		
230	1200							1680	1830	950	0.93	0.15	0.016	500	06	
353		1850						2100	1822	950	0.93	0.15	0.016	500		
375			1940					2100	1846	950	0.94	0.15	0.016	500		
393				2030				2100	1849	950	0.94	0.15	0.016	500		

1. Higher speed ranges by field weakening can be studied according to the application : consult us.

P : Rated power  
M : Rated moment  
I : Permissible current in continuous operation  
 $\eta$  : Efficiency  
L : Motor self-induction coil  
R : Armature resistance at 115°C  
 $U_{max}$  : Maximum armature voltage

# Open continuous current (DC) motors LSK 2804C SM

## Selection

IP 23S motor - IC 06 ventilation - Class H  
Full bridge three-phase power supply  
S1 duty - Ambient temperature  $\leq 40^{\circ}\text{C}$  - Total weight: 1800 kg - Inertia moment: 5.75 kg.m<sup>2</sup>  
Excitation power: 5.5 kW - Maximum mechanical speed: 2000 min<sup>-1</sup>

P	Rotation speed $n$ for armature voltage $U$							$n_{max}$	M	I	$\eta$	L	$R_{115^{\circ}}$	$U_{max}$	Index	Qty
	260 V min <sup>-1</sup>	400 V min <sup>-1</sup>	420 V min <sup>-1</sup>	440 V min <sup>-1</sup>	460 V min <sup>-1</sup>	500 V min <sup>-1</sup>	600 V min <sup>-1</sup>									
98	325							600	2880	430	0.88	0.96	0.109	650	01	
151		500						900	2884	430	0.88	0.96	0.109	650		
161			530					950	2901	430	0.89	0.96	0.109	650		
168				550				1000	2917	430	0.89	0.96	0.109	650		
176					580			1040	2898	430	0.89	0.96	0.109	650		
194						630		1130	2941	430	0.90	0.96	0.109	650		
235							750	1350	2992	430	0.91	0.96	0.109	650		
130	435							590	2854	560	0.89	0.52	0.074	750	02	
199		670						870	2836	560	0.89	0.52	0.074	750		
209			700					910	2851	560	0.89	0.52	0.074	750		
222				740				960	2865	560	0.90	0.52	0.074	750		
232					770			1000	2877	560	0.90	0.52	0.074	750		
252						840		1090	2865	560	0.90	0.52	0.074	750		
309							1000	1300	2951	560	0.92	0.52	0.074	750		
151	510							910	2828	640	0.91	0.36	0.047	750	03	
233		780						1300	2853	640	0.91	0.36	0.047	750		
245			820					1460	2853	640	0.91	0.36	0.047	750		
256				860				1550	2843	640	0.91	0.36	0.047	750		
271					900			1610	2876	640	0.92	0.36	0.047	750		
294						980		1750	2865	640	0.92	0.36	0.047	750		
357							1180	2000	2889	640	0.93	0.36	0.047	750		

1. Higher speed ranges by field weakening can be studied according to the application : consult us.

P : Rated power  
M : Rated moment  
I : Permissible current in continuous operation  
 $\eta$  : Efficiency  
L : Motor self-induction coil  
R : Armature resistance at 115°C  
 $U_{max}$  : Maximum armature voltage

# Open continuous current (DC) motors LSK 2804C M

## Selection

IP 23S motor - IC 06 ventilation - Class H  
Full bridge three-phase power supply  
S1 duty - Ambient temperature  $\leq 40^{\circ}\text{C}$  - Total weight: 1800 kg - Inertia moment: 5.75 kg.m<sup>2</sup>  
Excitation power: 5.5 kW - Maximum mechanical speed: 2000 min<sup>-1</sup>

P	Rotation speed $n$ for armature voltage $U$							$n_{max}$	M	I	$\eta$	L	$R_{115^{\circ}}$	$U_{max}$	Index	Qty
	260 V min <sup>-1</sup>	400 V min <sup>-1</sup>	420 V min <sup>-1</sup>	440 V min <sup>-1</sup>	460 V min <sup>-1</sup>	500 V min <sup>-1</sup>	600 V min <sup>-1</sup>									
199	650							910	2924	830	0.92	0.23	0.03	650	04	
305		1000						1400	2913	830	0.92	0.23	0.03	650		
321			1050					1470	2920	830	0.92	0.23	0.03	650		
340				1100				1540	2952	830	0.93	0.23	0.03	650		
355					1150			1610	2948	830	0.93	0.23	0.03	650		
386						1250		1750	2949	830	0.93	0.23	0.03	650		
468							1500	2000	2980	830	0.94	0.23	0.03	650		
235	810							1050	2771	970	0.93	0.16	0.02	550	05	
361		1250						1620	2758	970	0.93	0.16	0.02	550		
379			1310					1700	2763	970	0.93	0.16	0.02	550		
397				1375				1790	2757	970	0.93	0.16	0.02	550		
419					1440			1870	2779	970	0.94	0.16	0.02	550		
456						1560		2000	2792	970	0.94	0.16	0.02	550		
269	920							1250	2792	1100	0.94	0.125	0.0136	500	06	1
414		1420						1920	2784	1100	0.94	0.125	0.0136	500		
434			1490					2000	2782	1100	0.94	0.125	0.0136	500		
455				1560				2000	2785	1100	0.94	0.125	0.0136	500		
476					1630			2000	2789	1100	0.94	0.125	0.0136	500		
517						1775		2000	2782	1100	0.94	0.125	0.0136	500		
318	1090							1300	2786	1300	0.94	0.13	0.0082	460	07	
489		1680						2000	2780	1300	0.94	0.13	0.0082	460		
513			1765					2000	2776	1300	0.94	0.13	0.0082	460		
538				1850				2000	2777	1300	0.94	0.13	0.0082	460		
562					1930			2000	2781	1300	0.94	0.13	0.0082	460		

1. Higher speed ranges by field weakening can be studied according to the application : consult us.

P : Rated power  
M : Rated moment  
I : Permissible current in continuous operation  
 $\eta$  : Efficiency  
L : Motor self-induction coil  
R : Armature resistance at 115°C  
 $U_{max}$  : Maximum armature voltage

# Open continuous current (DC) motors LSK 2804C SL

## Selection

IP 23S motor - IC 06 ventilation - Class H  
Full bridge three-phase power supply  
S1 duty - Ambient temperature  $\leq 40^{\circ}\text{C}$  - Total weight: 1900 kg - Inertia moment: 6.9 kg.m<sup>2</sup>  
Excitation power: 5.5 kW - Maximum mechanical speed: 2000 min<sup>-1</sup>

P	Rotation speed $n$ for armature voltage $U$							$n_{max}$	M	I	$\eta$	L	$R_{115^{\circ}}$	$U_{max}$	Index	Qty
	260 V min <sup>-1</sup>	400 V min <sup>-1</sup>	420 V min <sup>-1</sup>	440 V min <sup>-1</sup>	460 V min <sup>-1</sup>	500 V min <sup>-1</sup>	600 V min <sup>-1</sup>									
98	270							500	3466	430	0.88	1.14	0.12	650	01	
151		420						750	3433	430	0.88	1.14	0.12	650		
161			440					790	3494	430	0.89	1.14	0.12	650		
168				460				830	3488	430	0.89	1.14	0.12	650		
176					480			870	3502	430	0.89	1.14	0.12	650		
194						525		940	3529	430	0.90	1.14	0.12	650		
235							630	1120	3562	430	0.91	1.14	0.12	650		
130	360							490	3449	560	0.89	0.62	0.081	750	02	
199		560						725	3394	560	0.89	0.62	0.081	750		
209			590					760	3383	560	0.89	0.62	0.081	750		
222				620				800	3420	560	0.90	0.62	0.081	750		
232					650			830	3409	560	0.90	0.62	0.081	750		
252						700		910	3438	560	0.90	0.62	0.081	750		
309							840	1080	3513	560	0.92	0.62	0.081	750		
151	425							760	3393	640	0.91	0.43	0.052	750	03	
233		650						1080	3423	640	0.91	0.43	0.052	750		
245			680					1220	3441	640	0.91	0.43	0.052	750		
256				720				1290	3396	640	0.91	0.43	0.052	750		
271					750			1340	3451	640	0.92	0.43	0.052	750		
294						820		1460	3424	640	0.92	0.43	0.052	750		
357							980	1750	3479	640	0.93	0.43	0.052	750		

1. Higher speed ranges by field weakening can be studied according to the application : consult us.

P : Rated power  
M : Rated moment  
I : Permissible current in continuous operation  
 $\eta$  : Efficiency  
L : Motor self-induction coil  
R : Armature resistance at 115°C  
 $U_{max}$  : Maximum armature voltage



# Open continuous current (DC) motors LSK 2804C L

## Selection

**IP 23S motor - IC 06 ventilation - Class H**  
**Full bridge three-phase power supply**  
**S1 duty - Ambient temperature  $\leq 40^{\circ}\text{C}$  - Total weight: 1900 kg - Inertia moment : 6.9 kg.m<sup>2</sup>**  
**Excitation power: 5.5 kW - Maximum mechanical speed: 2000 min<sup>-1</sup>**

P	Rotation speed $n$ for armature voltage $U$							$n_{max}$	M	I	$\eta$	L	$R_{115^{\circ}}$	$U_{max}$	Index	Qty
	260 V min <sup>-1</sup>	400 V min <sup>-1</sup>	420 V min <sup>-1</sup>	440 V min <sup>-1</sup>	460 V min <sup>-1</sup>	500 V min <sup>-1</sup>	600 V min <sup>-1</sup>									
199	540							760	3519	830	0.92	0.28	0.033	650	04	
305		830						1170	3509	830	0.92	0.28	0.033	650		
321			875					1220	3503	830	0.92	0.28	0.033	650		
340				920				1280	3529	830	0.93	0.28	0.033	650		
355					960			1340	3532	830	0.93	0.28	0.033	650		
386						1040		1460	3545	830	0.93	0.28	0.033	650		
468							1250	1750	3576	830	0.94	0.28	0.033	650		
235	675							875	3325	970	0.93	0.19	0.022	550	05	
361		1040						1350	3315	970	0.93	0.19	0.022	550		
379			1090					1420	3321	970	0.93	0.19	0.022	550		
397				1150				1490	3297	970	0.93	0.19	0.022	550		
419					1200			1560	3335	970	0.94	0.19	0.022	550		
456						1300		1700	3350	970	0.94	0.19	0.022	550		
269	770							1040	3336	1100	0.94	0.15	0.015	500	06	
414		1180						1600	3351	1100	0.94	0.15	0.015	500		
434			1240					1680	3343	1100	0.94	0.15	0.015	500		
455				1300				1760	3343	1100	0.94	0.15	0.015	500		
476					1360			1840	3343	1100	0.94	0.15	0.015	500		
517						1480		2000	3336	1100	0.94	0.15	0.015	500		
318	910							1080	3337	1300	0.94	0.155	0.0099	460	07	
489		1400						1670	3336	1300	0.94	0.155	0.0099	460		
513			1470					1750	3333	1300	0.94	0.155	0.0099	460		
538				1540				1830	3336	1300	0.94	0.155	0.0099	460		
562					1610			1920	3334	1300	0.94	0.155	0.0099	460		

1. Higher speed ranges by field weakening can be studied according to the application : consult us.

P : Rated power  
M : Rated moment  
I : Permissible current in continuous operation  
 $\eta$  : Efficiency  
L : Motor self-induction coil  
R : Armature resistance at 115°C  
 $U_{max}$  : Maximum armature voltage



# Open continuous current (DC) motors LSK 3554C VS

## Selection

IP 23S motor - IC 06 ventilation - Class H  
Full bridge three-phase power supply  
S1 duty - Ambient temperature  $\leq 40^{\circ}\text{C}$  - Total weight: 2250 kg - Inertia moment: 16.8 kg.m<sup>2</sup>  
Excitation power: 1.8 kW - Maximum mechanical speed: 2000 min<sup>-1</sup>

P	Rotation speed $n$ for armature voltage $U$							$n_{max}$	M	I	$\eta$	L	$R_{115^{\circ}}$	$U_{max}$	Index	Qty
	400 V min <sup>-1</sup>	440 V min <sup>-1</sup>	460 V min <sup>-1</sup>	500 V min <sup>-1</sup>	520 V min <sup>-1</sup>	600 V min <sup>-1</sup>	700 V min <sup>-1</sup>									
225	660							1060	3260	630	0.89	0.69	0.056	700	03	
249		730						1140	3260	630	0.90	0.69	0.056	700		
263			770					1190	3260	630	0.91	0.69	0.056	700		
287				840				1260	3260	630	0.91	0.69	0.056	700		
299					875			1300	3260	630	0.91	0.69	0.056	700		
348						1020		1430	3260	630	0.92	0.69	0.056	700		
410							1200	1560	3260	630	0.93	0.69	0.056	700		
243	715							1140	3250	684	0.89	0.58	0.046	700	04	
271		795						1240	3250	684	0.90	0.58	0.046	700		
282			830					1280	3250	684	0.90	0.58	0.046	700		
310				910				1370	3250	684	0.91	0.58	0.046	700		
323					950			1410	3250	684	0.91	0.58	0.046	700		
376						1105		1550	3250	684	0.92	0.58	0.046	700		
442							1300	1690	3250	684	0.92	0.58	0.046	700		
266	770							1230	3295	734	0.90	0.51	0.04	700	05	
293		850						1330	3295	734	0.91	0.51	0.04	700		
307			890					1370	3295	734	0.91	0.51	0.04	700		
336				975				1460	3295	734	0.92	0.51	0.04	700		
350					1015			1500	3295	734	0.92	0.51	0.04	700		
407						1180		1650	3295	734	0.92	0.51	0.04	700		
480							1390	1810	3295	734	0.93	0.51	0.04	700		
284	830							1330	3265	780	0.91	0.45	0.036	700	06	
313		915						1430	3265	780	0.91	0.45	0.036	700		
328			960					1480	3265	780	0.91	0.45	0.036	700		
359				1050				1580	3265	780	0.92	0.45	0.036	700		
374					1095			1620	3265	780	0.92	0.45	0.036	700		
434						1270		1780	3265	780	0.93	0.45	0.036	700		
511							1495	1940	3265	780	0.94	0.45	0.036	700		
323	925							1480	3330	880	0.92	0.36	0.029	700	07	
356		1020						1590	3330	880	0.92	0.36	0.029	700		
373			1070					1650	3330	880	0.92	0.36	0.029	700		
408				1170				1760	3330	880	0.93	0.36	0.029	700		
425					1220			1810	3330	880	0.93	0.36	0.029	700		
493						1415		1980	3330	880	0.93	0.36	0.029	700		
581							1665	2000	3330	880	0.94	0.36	0.029	700		

1. Higher speed ranges by field weakening can be studied according to the application : consult us.

P : Rated power  
M : Rated moment  
I : Permissible current in continuous operation  
 $\eta$  : Efficiency  
L : Motor self-induction coil  
R : Armature resistance at 115°C  
 $U_{max}$  : Maximum armature voltage

# Open continuous current (DC) motors LSK 3554C VS

## Selection

IP 23S motor - IC 06 ventilation - Class H  
Full bridge three-phase power supply  
S1 duty - Ambient temperature  $\leq 40^{\circ}\text{C}$  - Total weight: 2250 kg - Inertia moment : 16.8 kg.m<sup>2</sup>  
Excitation power: 1.8 kW - Maximum mechanical speed: 2000 min<sup>-1</sup>

P kW	Rotation speed $n$ for armature voltage $U$							$n_{max}$ Elec <sup>1</sup> min <sup>-1</sup>	M N.m	I A	$\eta$ Except for excit.	L mH	$R_{115^{\circ}}$ $\Omega$	$U_{max}$ V	Index	Qty
	400 V min <sup>-1</sup>	440 V min <sup>-1</sup>	460 V min <sup>-1</sup>	500 V min <sup>-1</sup>	520 V min <sup>-1</sup>	600 V min <sup>-1</sup>	700 V min <sup>-1</sup>									
354	1025						1640	3295	957	0.92	0.34	0.026	650	08		
392		1135					1770	3295	957	0.93	0.34	0.026	650			
411			1190				1830	3295	957	0.93	0.34	0.026	650			
449				1300			1950	3295	957	0.94	0.34	0.026	650			
468					1355		2000	3295	957	0.94	0.34	0.026	650			
543						1575	2000	3295	957	0.95	0.34	0.026	650			
378	1105						1770	3265	1020	0.93	0.29	0.023	600	09		
419		1225					1910	3265	1020	0.93	0.29	0.023	600			
438			1280				1970	3265	1020	0.93	0.29	0.023	600			
479				1400			2000	3265	1020	0.94	0.29	0.023	600			
499					1460		2000	3265	1020	0.94	0.29	0.023	600			
579						1695	2000	3265	1020	0.95	0.29	0.023	600			
411	1210						1940	3245	1105	0.93	0.22	0.017	550	10		
454		1335					2000	3245	1105	0.93	0.22	0.017	550			
476			1400				2000	3245	1105	0.94	0.22	0.017	550			
518				1525			2000	3245	1105	0.94	0.22	0.017	550			
540					1590		2000	3245	1105	0.94	0.22	0.017	550			
446	1325						2000	3215	1200	0.93	0.18	0.014	500		11	
493		1465					2000	3215	1200	0.93	0.18	0.014	500			
515			1530				2000	3215	1200	0.93	0.18	0.014	500			
562				1670			2000	3215	1200	0.94	0.18	0.014	500			
501	1445						2000	3310	1340	0.93	0.15	0.012	460	12		
553		1595					2000	3310	1340	0.94	0.15	0.012	460			
579			1670				2000	3310	1340	0.94	0.15	0.012	460			

1. Higher speed ranges by field weakening can be studied according to the application : consult us.

P : Rated power  
M : Rated moment  
I : Permissible current in continuous operation  
 $\eta$  : Efficiency  
L : Motor self-induction coil  
R : Armature resistance at 115°C  
 $U_{max}$  : Maximum armature voltage

# Open continuous current (DC) motors LSK 3554C S

## Selection

IP 23S motor - IC 06 ventilation - Class H  
Full bridge three-phase power supply  
S1 duty - Ambient temperature  $\leq 40^{\circ}\text{C}$  - Total weight: 2600 kg - Inertia moment: 19.7 kg.m<sup>2</sup>  
Excitation power: 1.9 kW - Maximum mechanical speed: 2000 min<sup>-1</sup>

P	Rotation speed $n$ for armature voltage $U$							$n_{max}$	M	I	$\eta$	L	$R_{115^{\circ}}$	$U_{max}$	Index	Qty
	400 V min <sup>-1</sup>	440 V min <sup>-1</sup>	460 V min <sup>-1</sup>	500 V min <sup>-1</sup>	520 V min <sup>-1</sup>	600 V min <sup>-1</sup>	700 V min <sup>-1</sup>									
224	525							840	4080	630	0.89	0.81	0.064	700	03	
250		585						910	4080	630	0.90	0.81	0.064	700		
261			610					940	4080	630	0.90	0.81	0.064	700		
286				670				1010	4080	630	0.91	0.81	0.064	700		
299					700			1040	4080	630	0.91	0.81	0.064	700		
348						815		1140	4080	630	0.92	0.81	0.064	700		
410							960	1250	4080	630	0.93	0.81	0.064	700		
244	575							920	4060	684	0.89	0.67	0.053	700	04	
270		635						990	4060	684	0.90	0.67	0.053	700		
283			665					1020	4060	684	0.90	0.67	0.053	700		
310				730				1100	4060	684	0.91	0.67	0.053	700		
323					760			1120	4060	684	0.91	0.67	0.053	700		
376						885		1240	4060	684	0.92	0.67	0.053	700		
444							1045	1360	4060	684	0.93	0.67	0.053	700		
263	610							980	4120	734	0.90	0.6	0.047	700	05	
293		680						1060	4120	734	0.91	0.6	0.047	700		
308			715					1100	4120	734	0.91	0.6	0.047	700		
337				780				1170	4120	734	0.92	0.6	0.047	700		
352					815			1210	4120	734	0.92	0.6	0.047	700		
410						950		1330	4120	734	0.93	0.6	0.047	700		
481							1115	1450	4120	734	0.94	0.6	0.047	700		
282	660							1060	4080	780	0.90	0.51	0.04	700	06	
312		730						1140	4080	780	0.91	0.51	0.04	700		
329			770					1190	4080	780	0.92	0.51	0.04	700		
359				840				1260	4080	780	0.92	0.51	0.04	700		
374					875			1300	4080	780	0.92	0.51	0.04	700		
436						1020		1430	4080	780	0.93	0.51	0.04	700		
513							1200	1560	4080	780	0.94	0.51	0.04	700		
320	735							1180	4160	880	0.91	0.41	0.033	700	07	
355		815						1270	4160	880	0.92	0.41	0.033	700		
372			855					1320	4160	880	0.92	0.41	0.033	700		
407				935				1400	4160	880	0.93	0.41	0.033	700		
425					975			1440	4160	880	0.93	0.41	0.033	700		
494						1135		1590	4160	880	0.94	0.41	0.033	700		
579							1330	1730	4160	880	0.94	0.41	0.033	700		

1. Higher speed ranges by field weakening can be studied according to the application : consult us.

P : Rated power  
M : Rated moment  
I : Permissible current in continuous operation  
 $\eta$  : Efficiency  
L : Motor self-induction coil  
R : Armature resistance at 115°C  
 $U_{max}$  : Maximum armature voltage

# Open continuous current (DC) motors LSK 3554C S

## Selection

IP 23S motor - IC 06 ventilation - Class H  
Full bridge three-phase power supply  
S1 duty - Ambient temperature  $\leq 40^{\circ}\text{C}$  - Total weight: 2600 kg - Inertia moment: 19.7 kg.m<sup>2</sup>  
Excitation power: 1.9 kW - Maximum mechanical speed: 2000 min<sup>-1</sup>

P kW	Rotation speed $n$ for armature voltage $U$							$n_{max}$ Elec <sup>1</sup> min <sup>-1</sup>	M N.m	I A	$\eta$ Except for excit.	L mH	$R_{115^{\circ}}$ $\Omega$	$U_{max}$ V	Index	Qty	
	400 V min <sup>-1</sup>	440 V min <sup>-1</sup>	460 V min <sup>-1</sup>	500 V min <sup>-1</sup>	520 V min <sup>-1</sup>	600 V min <sup>-1</sup>	700 V min <sup>-1</sup>										
354	820							1310	4120	957	0.92	0.33	0.026	650	08		
393		910						1420	4120	957	0.93	0.33	0.026	650			
410			950					1460	4120	957	0.93	0.33	0.026	650			
449				1040				1560	4120	957	0.94	0.33	0.026	650			
468					1085			1610	4120	957	0.94	0.33	0.026	650			
544						1260		1760	4120	957	0.95	0.33	0.026	650			
378	885							1420	4080	1020	0.93	0.29	0.023	600	09		
419		980						1530	4080	1020	0.93	0.29	0.023	600			
438			1025					1580	4080	1020	0.93	0.29	0.023	600			
478				1120				1680	4080	1020	0.94	0.29	0.023	600			
498					1165			1720	4080	1020	0.94	0.29	0.023	600			
579						1355		1900	4080	1020	0.95	0.29	0.023	600			
410	965							1540	4060	1105	0.93	0.24	0.019	550	10		
453		1065						1660	4060	1105	0.93	0.24	0.019	550			
476			1120					1720	4060	1105	0.94	0.24	0.019	550			
519				1220				1830	4060	1105	0.94	0.24	0.019	550			
540					1270			1880	4060	1105	0.94	0.24	0.019	550			
444	1055							1690	4020	1200	0.93	0.2	0.016	500		11	
493		1170						1830	4020	1200	0.93	0.2	0.016	500			
516			1225					1890	4020	1200	0.93	0.2	0.016	500			
562				1335				2000	4020	1200	0.94	0.2	0.016	500			
501	1155							1850	4140	1340	0.93	0.17	0.013	460	12		
553		1275						1990	4140	1340	0.94	0.17	0.013	460			
579			1335					2000	4140	1340	0.94	0.17	0.013	460			

1. Higher speed ranges by field weakening can be studied according to the application : consult us.

P : Rated power  
M : Rated moment  
I : Permissible current in continuous operation  
 $\eta$  : Efficiency  
L : Motor self-induction coil  
R : Armature resistance at 115°C  
 $U_{max}$  : Maximum armature voltage

# Open continuous current (DC) motors LSK 3554C M

## Selection

IP 23S motor - IC 06 ventilation - Class H  
Full bridge three-phase power supply  
S1 duty - Ambient temperature  $\leq 40^{\circ}\text{C}$  - Total weight: 2800 kg - Inertia moment: 21.1 kg.m<sup>2</sup>  
Excitation power: 2 kW - Maximum mechanical speed: 2000 min<sup>-1</sup>

P	Rotation speed $n$ for armature voltage $U$							$n_{max}$	M	I	$\eta$	L	$R_{115^{\circ}}$	$U_{max}$	Index	Qty
	400 V min <sup>-1</sup>	440 V min <sup>-1</sup>	460 V min <sup>-1</sup>	500 V min <sup>-1</sup>	520 V min <sup>-1</sup>	600 V min <sup>-1</sup>	700 V min <sup>-1</sup>									
223	475							760	4490	630	0.89	0.85	0.067	700	03	
249		530						830	4490	630	0.90	0.85	0.067	700		
261			555					850	4490	630	0.90	0.85	0.067	700		
287				610				920	4490	630	0.91	0.85	0.067	700		
299					635			940	4490	630	0.91	0.85	0.067	700		
350						745		1040	4490	630	0.93	0.85	0.067	700		
411							875	1140	4490	630	0.93	0.85	0.067	700		
243	520							830	4465	684	0.89	0.71	0.056	700	04	
271		580						900	4465	684	0.90	0.71	0.056	700		
283			605					930	4465	684	0.90	0.71	0.056	700		
311				665				1000	4465	684	0.91	0.71	0.056	700		
325					695			1030	4465	684	0.91	0.71	0.056	700		
379						810		1130	4465	684	0.92	0.71	0.056	700		
447							955	1240	4465	684	0.93	0.71	0.056	700		
264	555							890	4535	734	0.90	0.63	0.05	700	05	
294		620						970	4535	734	0.91	0.63	0.05	700		
309			650					1000	4535	734	0.91	0.63	0.05	700		
337				710				1070	4535	734	0.92	0.63	0.05	700		
351					740			1100	4535	734	0.92	0.63	0.05	700		
411						865		1210	4535	734	0.93	0.63	0.05	700		
482							1015	1320	4535	734	0.94	0.63	0.05	700		
282	600							960	4490	780	0.90	0.55	0.043	700	06	
313		665						1040	4490	780	0.91	0.55	0.043	700		
329			700					1080	4490	780	0.92	0.55	0.043	700		
360				765				1150	4490	780	0.92	0.55	0.043	700		
376					800			1180	4490	780	0.93	0.55	0.043	700		
437						930		1300	4490	780	0.93	0.55	0.043	700		
515							1095	1420	4490	780	0.94	0.55	0.043	700		
321	670							1070	4580	880	0.91	0.43	0.034	700	07	
355		740						1150	4580	880	0.92	0.43	0.034	700		
374			780					1200	4580	880	0.92	0.43	0.034	700		
408				850				1280	4580	880	0.93	0.43	0.034	700		
424					885			1310	4580	880	0.93	0.43	0.034	700		
494						1030		1440	4580	880	0.94	0.43	0.034	700		
580							1210	1570	4580	880	0.94	0.43	0.034	700		

1. Higher speed ranges by field weakening can be studied according to the application : consult us.

P : Rated power  
M : Rated moment  
I : Permissible current in continuous operation  
 $\eta$  : Efficiency  
L : Motor self-induction coil  
R : Armature resistance at 115°C  
 $U_{max}$  : Maximum armature voltage

# Open continuous current (DC) motors LSK 3554C M

## Selection

IP 23S motor - IC 06 ventilation - Class H  
Full bridge three-phase power supply  
S1 duty - Ambient temperature  $\leq 40^{\circ}\text{C}$  - Total weight: 2800 kg - Inertia moment: 21.1 kg.m<sup>2</sup>  
Excitation power: 2 kW - Maximum mechanical speed: 2000 min<sup>-1</sup>

P	Rotation speed $n$ for armature voltage $U$							$n_{max}$	M	I	$\eta$	L	$R_{115^{\circ}}$	$U_{max}$	Index	Qty	
	400 V min <sup>-1</sup>	440 V min <sup>-1</sup>	460 V min <sup>-1</sup>	500 V min <sup>-1</sup>	520 V min <sup>-1</sup>	600 V min <sup>-1</sup>	700 V min <sup>-1</sup>										Elec <sup>1</sup> min <sup>-1</sup>
354	745							1190	4535	957	0.92	0.36	0.028	650	08		
392		825						1290	4535	957	0.93	0.36	0.028	650			
411			865					1330	4535	957	0.93	0.36	0.028	650			
449				945				1420	4535	957	0.94	0.36	0.028	650			
468					985			1460	4535	957	0.94	0.36	0.028	650			
544						1145		1600	4490	957	0.95	0.36	0.028	650			
378	805							1290	4490	1020	0.93	0.3	0.024	600	09		
418		890						1390	4490	1020	0.93	0.3	0.024	600			
440			935					1440	4490	1020	0.94	0.3	0.024	600			
480				1020				1530	4490	1020	0.94	0.3	0.024	600			
501					1065			1580	4490	1020	0.94	0.3	0.024	600			
581						1235		1730	4490	1020	0.95	0.3	0.024	600			
411	880							1410	4465	1105	0.93	0.25	0.02	550	10		
454		970						1510	4465	1105	0.93	0.25	0.02	550			
475			1015					1560	4465	1105	0.93	0.25	0.02	550			
519				1110				1670	4465	1105	0.94	0.25	0.02	550			
540					1155			1710	4465	1105	0.94	0.25	0.02	550			
446	960							1540	4440	1200	0.93	0.22	0.017	500		11	
495		1065						1660	4440	1200	0.94	0.22	0.017	500			
518			1115					1720	4440	1200	0.94	0.22	0.017	500			
565				1215				1820	4440	1200	0.94	0.22	0.017	500			
501	1050							1680	4555	1340	0.93	0.18	0.014	460	12		
553		1160						1810	4555	1340	0.94	0.18	0.014	460			
580			1215					1870	4555	1340	0.94	0.18	0.014	460			

1. Higher speed ranges by field weakening can be studied according to the application : consult us.

P : Rated power  
M : Rated moment  
I : Permissible current in continuous operation  
 $\eta$  : Efficiency  
L : Motor self-induction coil  
R : Armature resistance at 115°C  
 $U_{max}$  : Maximum armature voltage

# Open continuous current (DC) motors LSK 3554C L

## Selection

IP 23S motor - IC 06 ventilation - Class H  
Full bridge three-phase power supply  
S1 duty - Ambient temperature  $\leq 40^{\circ}\text{C}$  - Total weight: 3200 kg - Inertia moment: 23.9 kg.m<sup>2</sup>  
Excitation power: 2.1 kW - Maximum mechanical speed: 2000 min<sup>-1</sup>

P	Rotation speed $n$ for armature voltage $U$							$n_{max}$	M	I	$\eta$	L	$R_{115^{\circ}}$	$U_{max}$	Index	Qty
	400 V min <sup>-1</sup>	440 V min <sup>-1</sup>	460 V min <sup>-1</sup>	500 V min <sup>-1</sup>	520 V min <sup>-1</sup>	600 V min <sup>-1</sup>	700 V min <sup>-1</sup>									
222	400							640	5305	630	0.88	0.96	0.076	700	03	
247		445						690	5305	630	0.89	0.96	0.076	700		
261			470					720	5305	630	0.90	0.96	0.076	700		
286				515				770	5305	630	0.91	0.96	0.076	700		
300					540			800	5305	630	0.92	0.96	0.076	700		
350						630		880	5305	630	0.93	0.96	0.076	700		
414							745	970	5305	630	0.94	0.96	0.076	700		
242	440							700	5250	684	0.88	0.81	0.064	700	04	
269		490						760	5250	684	0.90	0.81	0.064	700		
283			515					790	5250	684	0.90	0.81	0.064	700		
311				565				850	5250	684	0.91	0.81	0.064	700		
324					590			870	5250	684	0.91	0.81	0.064	700		
379						690		970	5250	684	0.92	0.81	0.064	700		
448							815	1060	5250	684	0.94	0.81	0.064	700		
264	470							750	5355	734	0.90	0.72	0.057	700	05	
292		520						810	5355	734	0.90	0.72	0.057	700		
308			550					850	5355	734	0.91	0.72	0.057	700		
336				600				900	5355	734	0.92	0.72	0.057	700		
350					625			930	5355	734	0.92	0.72	0.057	700		
409						730		1020	5355	734	0.93	0.72	0.057	700		
482							860	1120	5355	734	0.94	0.72	0.057	700		
283	510							820	5305	780	0.91	0.62	0.049	700	06	
314		565						880	5305	780	0.91	0.62	0.049	700		
331			595					920	5305	780	0.92	0.62	0.049	700		
361				650				980	5305	780	0.93	0.62	0.049	700		
378					680			1010	5305	780	0.93	0.62	0.049	700		
439						790		1110	5305	780	0.94	0.62	0.049	700		
517							930	1210	5305	780	0.95	0.62	0.049	700		
320	565							900	5410	880	0.91	0.5	0.039	700	07	
354		625						980	5410	880	0.91	0.5	0.039	700		
374			660					1020	5410	880	0.92	0.5	0.039	700		
408				720				1080	5410	880	0.93	0.5	0.039	700		
425					750			1110	5410	880	0.93	0.5	0.039	700		
496						875		1230	5410	880	0.94	0.5	0.039	700		
583							1030	1340	5410	880	0.95	0.5	0.039	700		

1. Higher speed ranges by field weakening can be studied according to the application : consult us.

P : Rated power  
M : Rated moment  
I : Permissible current in continuous operation  
 $\eta$  : Efficiency  
L : Motor self-induction coil  
R : Armature resistance at 115°C  
 $U_{max}$  : Maximum armature voltage



# Open continuous current (DC) motors LSK 3554C L

## Selection

IP 23S motor - IC 06 ventilation - Class H  
Full bridge three-phase power supply  
S1 duty - Ambient temperature  $\leq 40^{\circ}\text{C}$  - Total weight: 3200 kg - Inertia moment: 23.9 kg.m<sup>2</sup>  
Excitation power: 2.1 kW - Maximum mechanical speed: 2000 min<sup>-1</sup>

P kW	Rotation speed $n$ for armature voltage $U$							$n_{max}$ Elec <sup>1</sup> min <sup>-1</sup>	M N.m	I A	$\eta$ Except for excit.	L mH	$R_{115^{\circ}}$ $\Omega$	$U_{max}$ V	Index	Qty
	400 V min <sup>-1</sup>	440 V min <sup>-1</sup>	460 V min <sup>-1</sup>	500 V min <sup>-1</sup>	520 V min <sup>-1</sup>	600 V min <sup>-1</sup>	700 V min <sup>-1</sup>									
353	630						1010	5355	957	0.92	0.41	0.032	650	08		
393		700					1090	5355	957	0.93	0.41	0.032	650			
409			730				1120	5355	957	0.93	0.41	0.032	650			
449				800			1200	5355	957	0.94	0.41	0.032	650			
468					835		1240	5355	957	0.94	0.41	0.032	650			
544						970	1360	5355	957	0.95	0.41	0.032	650			
378	680						1090	5305	1020	0.93	0.34	0.027	600	09		
419		755					1180	5305	1020	0.93	0.34	0.027	600			
439			790				1220	5305	1020	0.94	0.34	0.027	600			
481				865			1300	5305	1020	0.94	0.34	0.027	600			
500					900		1330	5305	1020	0.94	0.34	0.027	600			
583						1050	1470	5305	1020	0.95	0.34	0.027	600			
409	740						1180	5275	1105	0.92	0.30	0.023	550	10		
453		820					1280	5275	1105	0.93	0.30	0.023	550			
475			860				1320	5275	1105	0.93	0.30	0.023	550			
519				940			1410	5275	1105	0.94	0.30	0.023	550			
541					980		1450	5275	1105	0.94	0.30	0.023	550			
448	815						1300	5250	1200	0.93	0.24	0.019	500		11	
495		900					1400	5250	1200	0.94	0.24	0.019	500			
520			945				1460	5250	1200	0.94	0.24	0.019	500			
566				1030			1550	5250	1200	0.94	0.24	0.019	500			
502	890						1420	5385	1340	0.94	0.2	0.016	460	12		
555		985					1540	5385	1340	0.94	0.2	0.016	460			
581			1030				1590	5385	1340	0.94	0.2	0.016	460			

1. Higher speed ranges by field weakening can be studied according to the application : consult us.

P : Rated power  
M : Rated moment  
I : Permissible current in continuous operation  
 $\eta$  : Efficiency  
L : Motor self-induction coil  
R : Armature resistance at 115°C  
 $U_{max}$  : Maximum armature voltage

# Open continuous current (DC) motors LSK 3554C VL

## Selection

IP 23S motor - IC 06 ventilation - Class H  
Full bridge three-phase power supply  
S1 duty - Ambient temperature  $\leq 40^{\circ}\text{C}$  - Total weight: 3800 kg - Inertia moment: 28.3 kg.m<sup>2</sup>  
Excitation power: 2.2 kW - Maximum mechanical speed: 2000 min<sup>-1</sup>

P	Rotation speed $n$ for armature voltage $U$							$n_{max}$	M	I	$\eta$	L	$R_{115^{\circ}}$	$U_{max}$	Index	Qty
	400 V min <sup>-1</sup>	440 V min <sup>-1</sup>	460 V min <sup>-1</sup>	500 V min <sup>-1</sup>	520 V min <sup>-1</sup>	600 V min <sup>-1</sup>	700 V min <sup>-1</sup>									
222	325						520	6530	630	0.88	1.18	0.088	700	03		
250		365					570	6530	630	0.90	1.18	0.088	700			
260			380				590	6530	630	0.90	1.18	0.088	700			
287				420			630	6530	630	0.91	1.18	0.088	700			
301					440		650	6530	630	0.92	1.18	0.088	700			
352						515	720	6530	630	0.93	1.18	0.088	700			
417							790	6530	630	0.95	1.18	0.088	700			
240	355						570	6460	684	0.88	1	0.075	700	04		
271		400					620	6460	684	0.90	1	0.075	700			
284			420				650	6460	684	0.90	1	0.075	700			
311				460			690	6460	684	0.91	1	0.075	700			
325					480		710	6460	684	0.91	1	0.075	700			
382						565	790	6460	684	0.93	1	0.075	700			
450							860	6460	684	0.94	1	0.075	700			
262	380						610	6590	734	0.89	0.89	0.067	700	05		
293		425					660	6590	734	0.91	0.89	0.067	700			
307			445				690	6590	734	0.91	0.89	0.067	700			
338				490			740	6590	734	0.92	0.89	0.067	700			
352					510		750	6590	734	0.92	0.89	0.067	700			
414						600	840	6590	734	0.94	0.89	0.067	700			
486							920	6590	734	0.95	0.89	0.067	700			
284	415						660	6530	780	0.91	0.76	0.058	700	06		
315		460					720	6530	780	0.92	0.76	0.058	700			
332			485				750	6530	780	0.92	0.76	0.058	700			
362				530			800	6530	780	0.93	0.76	0.058	700			
379					555		820	6530	780	0.94	0.76	0.058	700			
441						645	900	6530	780	0.94	0.76	0.058	700			
523							990	6530	780	0.96	0.76	0.058	700			
321	460						740	6660	880	0.91	0.5	0.039	700	07		
356		510					800	6660	880	0.92	0.61	0.045	700			
373			535				820	6660	880	0.92	0.61	0.045	700			
408				585			880	6660	880	0.93	0.61	0.045	700			
425					610		900	6660	880	0.93	0.61	0.045	700			
495						710	990	6660	880	0.94	0.61	0.045	700			
586							840	1090	6660	880	0.95	0.61	0.045		700	

1. Higher speed ranges by field weakening can be studied according to the application : consult us.

P : Rated power  
M : Rated moment  
I : Permissible current in continuous operation  
 $\eta$  : Efficiency  
L : Motor self-induction coil  
R : Armature resistance at 115°C  
 $U_{max}$  : Maximum armature voltage

# Open continuous current (DC) motors LSK 3554C VL

## Selection

IP 23S motor - IC 06 ventilation - Class H  
Full bridge three-phase power supply  
S1 duty - Ambient temperature  $\leq 40^{\circ}\text{C}$  - Total weight: 3800 kg - Inertia moment: 28.3 kg.m<sup>2</sup>  
Excitation power: 2.2 kW - Maximum mechanical speed: 2000 min<sup>-1</sup>

P kW	Rotation speed $n$ for armature voltage $U$							$n_{max}$ Elec <sup>1</sup> min <sup>-1</sup>	M N.m	I A	$\eta$ Except for excit.	L mH	$R_{115^{\circ}}$ $\Omega$	$U_{max}$ V	Index	Qty
	400 V min <sup>-1</sup>	440 V min <sup>-1</sup>	460 V min <sup>-1</sup>	500 V min <sup>-1</sup>	520 V min <sup>-1</sup>	600 V min <sup>-1</sup>	700 V min <sup>-1</sup>									
352	510						820	6590	957	0.92	0.5	0.038	650	08		
390		565					880	6590	957	0.93	0.5	0.038	650			
411			595				920	6590	957	0.93	0.5	0.038	650			
449				650			980	6590	957	0.94	0.5	0.038	650			
469					680		1010	6590	957	0.94	0.5	0.038	650			
545						790	1110	6590	957	0.95	0.5	0.038	650			
376	550						880	6530	1020	0.92	0.42	0.031	600	09		
417		610					950	6530	1020	0.93	0.42	0.031	600			
438			640				990	6530	1020	0.93	0.42	0.031	600			
479				700			1050	6530	1020	0.94	0.42	0.031	600			
499					730		1080	6530	1020	0.94	0.42	0.031	600			
581						850	1190	6530	1020	0.95	0.42	0.031	600			
408	600						960	6490	1105	0.92	0.36	0.027	550	10		
452		665					1040	6490	1105	0.93	0.36	0.027	550			
476			700				1080	6490	1105	0.94	0.36	0.027	550			
520				765			1150	6490	1105	0.94	0.36	0.027	550			
544					800		1180	6490	1105	0.95	0.36	0.027	550			
446	660						1060	6460	1200	0.93	0.24	0.019	500		11	
494		730					1140	6460	1200	0.94	0.29	0.022	500			
517			765				1180	6460	1200	0.94	0.29	0.022	500			
565				835			1250	6460	1200	0.94	0.29	0.022	500			
499	720						1150	6625	1340	0.93	0.25	0.019	460	12		
552		795					1240	6625	1340	0.94	0.25	0.019	460			
579			835				1290	6625	1340	0.94	0.25	0.019	460			

1. Higher speed ranges by field weakening can be studied according to the application : consult us.

P : Rated power  
M : Rated moment  
I : Permissible current in continuous operation  
 $\eta$  : Efficiency  
L : Motor self-induction coil  
R : Armature resistance at 115°C  
 $U_{max}$  : Maximum armature voltage

# Open continuous current (DC) motors LSK

## Selection

Normal  
use

**Brake option**  
**Separate power supply by continuous or rectified current**  
**Ambient temperature  $\leq 40^{\circ}\text{C}$**   
**Manual release - Optional tachometric detector**

Brake Type	Motor frame size	$J_F$ 10 <sup>-3</sup> m <sup>2</sup> kg	$M_F$ N.m	$n_{s,maxi}$ min <sup>-1</sup>	$P_F$ W	$t_1^*$ ms	$t_2^*$ ms	$t_F^*$ ms	$U_F$ V	Weight kg
458	112	0.45	32	3000	40	111	29	28	24	3.5
458	112-132	0.63	60	3000	50	213	15	23	24	5.2
458	112-132	1.5	80	3000	55	221	23	30	24	7.9
458	132-160	2.9	150	3000	85	272	32	53	24	12
458	160	7.3	260	3000	100	320	50	100	24	19.3
458	160	20	400	3000	110	375	108	111	24	29.1

\* : Data for information only, these times allow not to use the brakes unnecessarily by delaying motor starting. Energization times correspond to D.C. switching. They can increase slightly according to the air-gap. They also take into consideration the voltage at the brake coil terminals.

Intensive  
use

For intensive use, consult us.

$J_F$  : Brake inertia

$M_F$  : Brake moment

$n_{s,max}$  : Maximum permissible speed on engagement

$P_F$  : Power of the brake coil

$t_1$  : Response time on release

$t_2$  : Response time on engagement

$t_F$  : Braking time

$U_F$  : Supply voltage (rectified or continuous current)



# Open continuous current (DC) motors LSK

## Availability according to the construction

LEROY-SOMER has set up an industrial organisation which meets the requirements of its customers in terms of delivery times and construction.

Three Service levels are available:

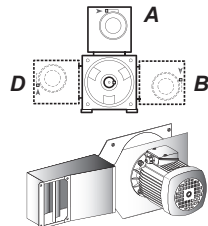
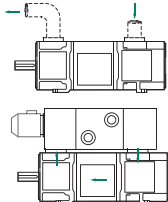
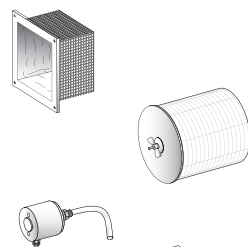
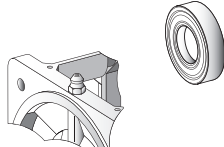
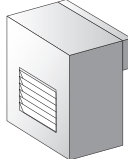
- Dispatch within 24 hours: **white**
- Dispatch of special products within 10 days: **grey**
- Delivery to be agreed for any special manufacture according to specification: **blue**.

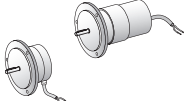
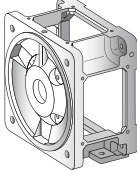
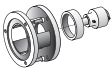
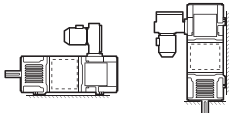
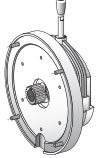
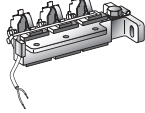
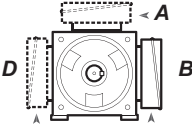
	<p><b>Adaptation to the environment</b></p> <ul style="list-style-type: none"> <li>• Field voltage           <ul style="list-style-type: none"> <li>- 180 / 360 V</li> <li>- <b>Other</b></li> </ul> </li> <li>• Thermal detection           <ul style="list-style-type: none"> <li>- PTC</li> <li>- PTO, 2nd set of probes</li> </ul> </li> <li>• Environment           <ul style="list-style-type: none"> <li>- TC impregnation</li> <li>- <b>Space heaters</b></li> </ul> </li> </ul>		<p><b>Forced Ventilation VF</b></p> <ul style="list-style-type: none"> <li>• Radial           <ul style="list-style-type: none"> <li>- Possible positions: D, A, B</li> </ul> </li> <li>• Axial</li> </ul>
	<p><b>Protection</b></p> <ul style="list-style-type: none"> <li>- IP 23S, IP 44R</li> <li>- IP 55R</li> <li>- <b>IP 55 with exchangers:</b> air / air or air / water</li> </ul>		<p><b>VF equipped with:</b></p> <ul style="list-style-type: none"> <li>• Standard filter</li> <li>• <b>Renewable filter</b></li> <li>• Stopped air flow detector</li> <li>• <b>Sound screen</b></li> </ul>
	<p><b>Bearings</b></p> <ul style="list-style-type: none"> <li>- Standard ball bearings</li> <li>- Roller bearings</li> <li>- <b>Ball bearings with grease nipple</b> (frame size &lt; 180)</li> </ul>		
	<p><b>Main shaft extension</b></p> <ul style="list-style-type: none"> <li>- Standard</li> <li>- <b>Special</b></li> </ul>		<p><b>Sensor</b></p> <ul style="list-style-type: none"> <li>- D.C. tachometric dynamo 60V 1000 min<sup>-1</sup></li> <li>- 1024 ppt encoder</li> </ul>
	<p><b>Mounting</b></p> <ul style="list-style-type: none"> <li>- Foot or standard flange</li> <li>- Foot &amp; standard flange</li> <li>- <b>Special flange</b></li> <li>- <b>Non IEC dimensions</b></li> </ul>		<p><b>Support &amp; coupling</b> (for mounting a speed detector)</p> <p><b>2<sup>nd</sup> shaft extension</b></p>
<p>IM 1001    IM 2011 ...</p> 	<p><b>Mounting</b></p> <ul style="list-style-type: none"> <li>- All positions</li> </ul>		<p><b>Mechanical brake</b></p> <ul style="list-style-type: none"> <li>- <b>without speed detection</b></li> <li>- <b>with speed detection</b></li> </ul>
	<p><b>Brush wear limit sensor</b></p>		<p><b>Terminal box position</b></p> <ul style="list-style-type: none"> <li>- B</li> <li>- D, A</li> </ul>



# Open continuous current (DC) motors LSK

## Dimensions

Dimensions of the LSK open continuous current (dc) motors  
IP 23S - IC 06

Dimensions in millimetres

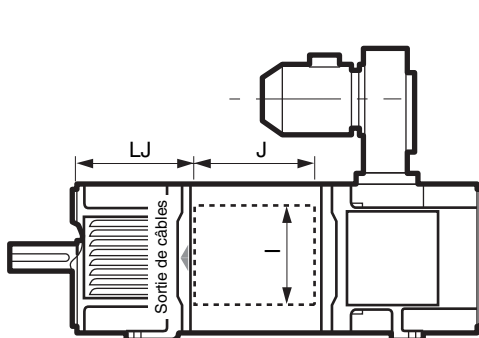
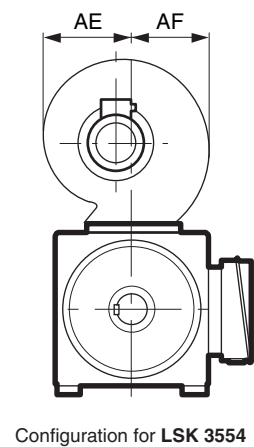
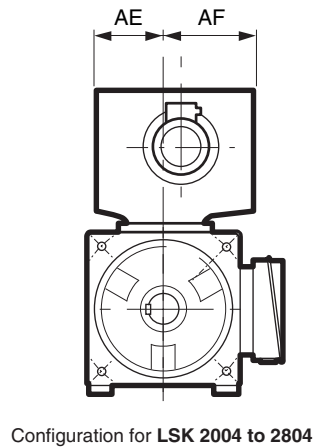
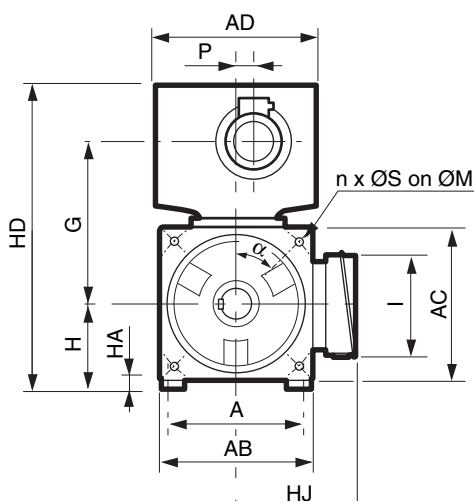
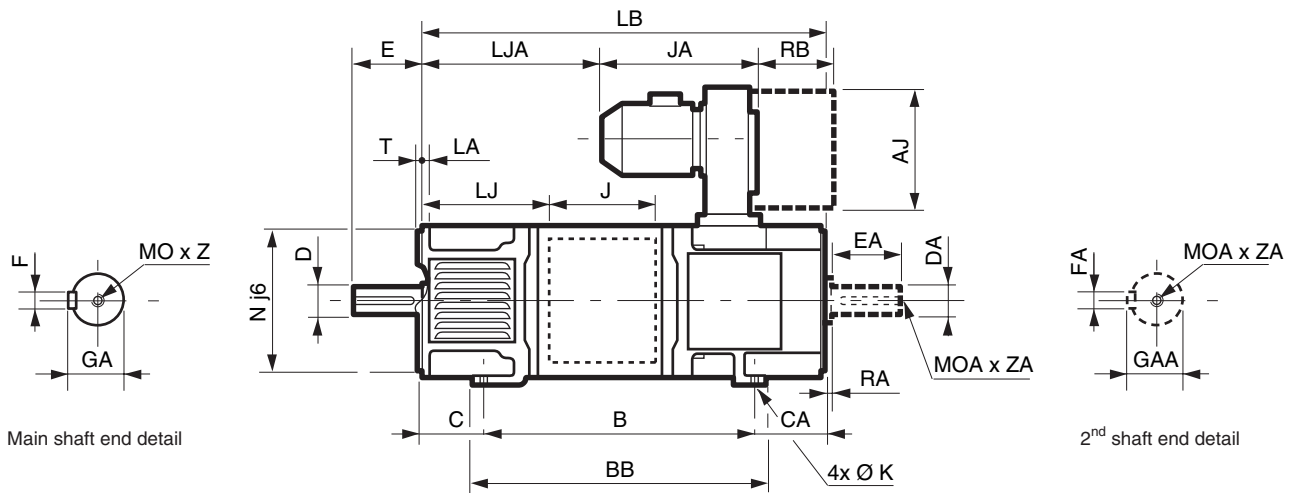

Terminals box detail : LSK 1804 to 2804C

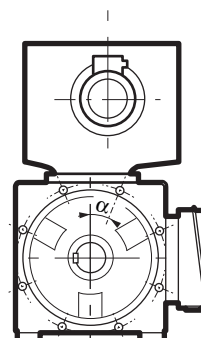

Flange configuration for LSK 2254 to 3554

# Open continuous current (DC) motors LSK

## Dimensions

### Dimensions off the LSK open continuous current (dc) motors IP 23S - IC 06

Dimensions in millimetres

Type	Main dimensions																						
	A	AB	AC	AD	AE	AF	B	BB	C	CA	G	H	HA	HD	HJ	I	J	JA	K	LB	LJ	LJA	P
LSK 1124 M	190	220	220	220	-	-	380	404	70	96	248	112	10	472	202	168	182	297	12	546	183	199	17
LSK 1124 L	190	220	220	220	-	-	450	474	70	96	248	112	10	472	202	168	182	297	12	616	253	269	17
LSK 1124 VL	190	220	220	220	-	-	520	544	70	96	248	112	10	472	202	168	182	297	12	686	323	339	17
LSK 1324 S	216	245	260	260	-	-	432	462	89	69	290	132	12	552	248	200	178	315	12	590	165	205	18
LSK 1324 M	216	245	260	260	-	-	482	512	89	69	290	132	12	552	248	200	178	315	12	640	215	255	18
LSK 1324 VL	216	245	260	260	-	-	582	612	89	69	290	132	12	552	248	200	178	315	12	740	315	355	18
LSK 1324 XVL	216	245	260	260	-	-	652	682	89	69	290	132	12	552	248	200	178	315	12	810	385	425	18
LSK 1604 S	254	300	316	318	-	-	425	469	103	222	361	160	15	678	313	250	217	353	14	750	271	293	20
LSK 1604 M	254	300	316	318	-	-	505	549	103	222	361	160	15	678	313	250	217	353	14	830	351	373	20
LSK 1604 L	254	300	316	318	-	-	565	609	103	222	361	160	15	678	313	250	217	353	14	890	411	433	20
LSK 1604 VL	254	300	316	318	-	-	665	709	103	222	361	160	15	678	313	250	217	353	14	990	511	533	20
LSK1804 M	279	356	356	318	-	-	653	738	121	115	396	180	15	735	317	230	270	353	14	889	340	434	20
LSK 1804 L	279	356	356	318	-	-	698	783	121	115	396	180	15	735	317	230	270	353	14	934	385	481	20
LSK 1804 VL	279	356	358	356	-	-	883	968	121	95	405	180	15	760	317	230	270	415	14	1099	505	554	23
LSK 1804C M	279	356	356	318	-	-	653	738	121	115	396	180	15	735	317	230	270	353	14	889	340	434	20
LSK 1804C L	279	356	356	318	-	-	698	783	121	115	396	180	15	735	317	230	270	353	14	934	385	481	20
LSK 2004 M	318	396	396	-	197	298	737	830	133	130	471	200	18	921	335	230	270	410	18	1000	420	489	73
LSK 2004 L	318	396	396	-	197	298	802	895	133	130	471	200	18	921	335	230	270	410	18	1065	485	554	73
LSK 2254 M	356	445	445	-	207	341	793.5	888	149	147.5	491	225	21	993	360	262	320	427	18	1090	452	515	92
LSK 2254 L	356	445	445	-	207	341	863.5	958	149	147.5	491	225	21	993	360	262	320	427	18	1160	522	585	92
LSK 2254 VL	356	445	445	-	207	341	913.5	1008	149	147.5	491	225	21	993	360	262	320	427	18	1210	572	635	92
LSK 2504C M	406	494	494	-	240	360	1018	1216	168	174	624	250	22	1180	495	470	340	416	22	1360	400	776	90
LSK 2504C L	406	494	494	-	240	360	1078	1276	168	174	624	250	22	1180	495	470	340	416	22	1420	460	836	90
LSK 2804C SM	457	550	550	-	275	380	1106	1248	190	182	660	280	29	1300	530	470	340	485	22	1477	655	871	62
LSK 2804C M	457	550	550	-	275	380	1106	1315	190	249	660	280	29	1300	530	470	340	485	22	1544	655	836	62
LSK 2804C SL	457	550	550	-	275	380	1216	1358	190	182	660	280	29	1300	530	470	340	485	22	1587	765	981	62
LSK 2804C L	457	550	550	-	275	380	1216	1425	190	249	660	280	29	1300	530	470	340	485	22	1654	765	946	62
LSK 3554C VS	610	700	700	-	374	331	700	1536	254 <sup>1</sup>	617	815	355	22.5	1521	680	434	520	621	27	1580 <sup>1</sup>	336 <sup>1</sup>	680 <sup>1</sup>	72
LSK 3554C S	610	700	700	-	374	331	800	1636	254 <sup>1</sup>	617	815	355	22.5	1521	680	434	520	621	27	1680 <sup>1</sup>	436 <sup>1</sup>	785 <sup>1</sup>	72
LSK 3554C M	610	700	700	-	374	331	850	1686	254 <sup>1</sup>	617	815	355	22.5	1521	680	434	520	621	27	1780 <sup>1</sup>	486 <sup>1</sup>	835 <sup>1</sup>	72
LSK 3554C L	610	700	700	-	374	331	950	1786	254 <sup>1</sup>	617	815	355	22.5	1521	680	434	520	621	27	1880 <sup>1</sup>	586 <sup>1</sup>	935 <sup>1</sup>	72
LSK 3554C VL	610	700	700	-	374	331	1100	1936	254 <sup>1</sup>	617	815	355	22.5	1521	680	434	520	621	27	1980 <sup>1</sup>	736 <sup>1</sup>	1085 <sup>1</sup>	72

Type	Shaft end												Filter		Standard flange <sup>2</sup>						
	D	DA	E	EA	F	FA	GA	GAA	O	OA	RA	Z	ZA	AJ	RB	LA	M	Nj6	n <sup>∠</sup>	S	T
LSK 1124	38 k6	38 k6	80	80	10	10	41	41	12	12	3	28	28	220	135	20	265	230	4	14	4
LSK 1324	48 k6	48 k6	110	110	14	14	51.5	51.5	16	16	3	36	36	260	135	22	300	250	4	18	5
LSK 1604	55 m6	55 m6	110	110	16	16	59	59	20	20	3	42	42	318	185	24	350	300	4	18	5
LSK 1804 M-L	60 m6	60 m6	140	140	18	18	64	64	20	20	6	42	42	318	185	20	350	300	4	18	5
LSK 1804 VL	60 m6	60 m6	140	140	18	18	64	64	20	20	6	42	42	356	200	20	350	300	4	18	5
LSK 1804C	60 m6	60 m6	140	140	18	18	64	64	20	20	6	42	42	318	185	20	350	300	4	18	5
LSK 2004	65 m6	65 m6	140	140	18	18	69	69	20	20	3	42	42	490	189	20	400	350	4	18	5
LSK 2254	80 m6	80 m6	170	170	22	22	85	85	20	20	1.5	36	36	500	230	31	400	350	8	18	5
LSK 2504C	100 m6	100 m6	170	170	28	28	106	106	24	24	1.5	50	50	460	356	35	400	350	8	18	5
LSK 2804C	110 m6	110 m6	170	170	28	28	116	116	24	24	1.5	50	50	620	180	46	500	450	8	26	6
LSK 3554C	125 m6	110 m6	210 <sup>1</sup>	210	32	28	132	116	24	24	-	50	50	600	400	28	940	880	8	25	6

1. The forward dimensions (D.E.) are established at the level of the shaft shoulder.

2. Other possibilities: see page B3.58

∠ : a = 45 degrees for n=4 ; a = 22 degrees 30 for n=8.

# Open continuous current (DC) motors LSK

## Dimensions

### Dimensions of the inspection doors or connection of air pipes IC 37 ventilation

Dimensions in millimetres

LSK 1124 to 2254  
and LSK 3554C

LSK 2504C & 2804C

Bottom inspection doors for brush  
or bottom connections  
to air pipes

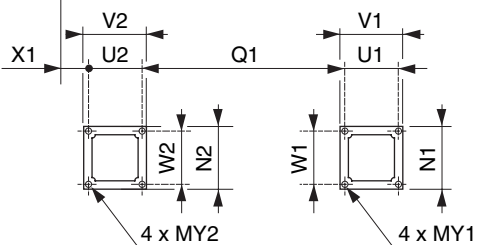
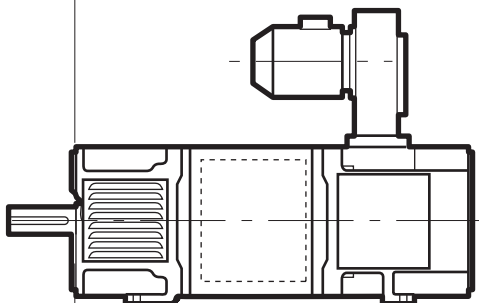
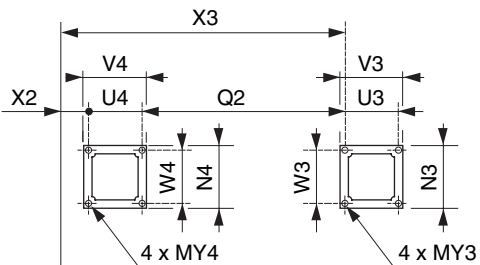

Top and side connexions  
to air pipes

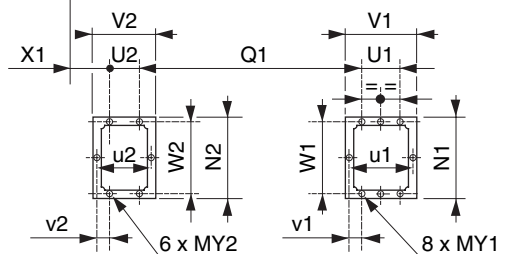
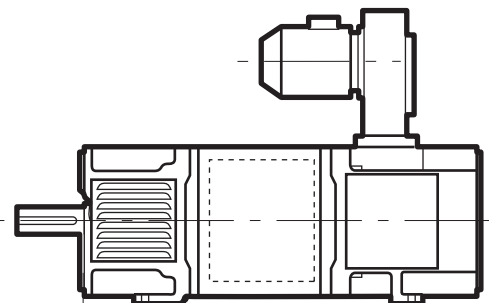

Connections to air pipes :  
top, side and bottom



# Open continuous current (DC) motors LSK

## Dimensions

### Dimensions of the inspection doors or connection of the air pipes IC 17 - IC 26 - IC 27 - IC 37

Dimensions in millimetres

Type	Main dimensions																							
	N1/N2	N3/N4	Q1	Q2	U1	U2	U3	U4	V1	V2	V3	V4	W1	W2	W3	W4	X1	X2	X3	Y1	Y2	Y3	Y4	
LSK 1124 M	130	130/-	225	-	114	114	114	-	130	130	130	-	114	114	114	-	30	30	369	6	6	6	-	
LSK 1124 L	130	130/-	296	-	114	114	114	-	130	130	130	-	114	114	114	-	30	30	440	6	6	6	-	
LSK 1124 VL	130	130/-	366	-	114	114	114	-	130	130	130	-	114	114	114	-	30	30	510	6	6	6	-	
LSK 1324 S	160	130/-	216	-	140	140	114	-	160	160	130	-	140	140	114	-	22	22	378	8	8	8	-	
LSK 1324 M	160	130/-	266	-	140	140	114	-	160	160	130	-	140	140	114	-	22	22	428	8	8	8	-	
LSK 1324 VL	160	130/-	366	-	140	140	114	-	160	160	130	-	140	140	114	-	22	22	528	8	8	8	-	
LSK 1324 XVL	160	130/-	436	-	140	140	114	-	160	160	130	-	140	140	144	-	22	22	611	8	8	8	-	
LSK 1604 S	190	190/-	346	-	135	135	135	-	150	150	150	-	175	175	175	-	23	23	504	8	8	8	-	
LSK 1604 M	190	190/-	426	-	135	135	135	-	150	150	150	-	175	175	175	-	23	23	584	8	8	8	-	
LSK 1604 L	190	190/-	486	-	135	135	135	-	150	150	150	-	175	175	175	-	23	23	644	8	8	8	-	
LSK 1604 VL	190	190/-	586	-	135	135	135	-	150	150	150	-	175	175	175	-	23	23	744	8	8	8	-	
LSK1804 M	215	215	479	479	140	140	140	140	180	180	180	180	200	200	200	200	25	25	644	6	6	6	6	
LSK 1804 L	215	215	524	524	140	140	140	140	180	180	180	180	200	200	200	200	25	25	689	6	6	6	6	
LSK 1804 VL	215	215	659	659	140	140	140	140	180	180	180	180	200	200	200	200	25	25	824	6	6	6	6	
LSK 1804C M	215	215	479	479	140	140	140	140	180	180	180	180	200	200	200	200	25	25	644	6	6	6	6	
LSK 1804C L	215	215	524	524	140	140	140	140	180	180	180	180	200	200	200	200	25	25	689	6	6	6	6	
LSK 2004 M	225	225	539	539	165	165	165	165	205	205	205	205	205	205	205	205	24	24	728	6	6	6	6	
LSK 2004 L	225	225	604	604	165	165	165	165	205	205	205	205	205	205	205	205	24	24	793	6	6	6	6	
LSK 2254 M	250	250	572	572	170	170	170	170	210	210	210	210	230	230	230	230	31	31	773	6	6	6	6	
LSK 2254 L	250	250	642	642	170	170	170	170	210	210	210	210	230	230	230	230	31	31	843	6	6	6	6	
LSK 2254 VL	250	250	692	692	170	170	170	170	210	210	210	210	230	230	230	230	31	31	893	6	6	6	6	
LSK 3554C VS	396	396	649	649	326	326	326	326	356	356	356	356	366	366	366	366	39'	39'	1014'	8	8	8	8	
LSK 3554C S	396	396	749	749	326	326	326	326	356	356	356	356	366	366	366	366	39'	39'	1114'	8	8	8	8	
LSK 3554C M	396	396	799	799	326	326	326	326	356	356	356	356	366	366	366	366	39'	39'	1164'	8	8	8	8	
LSK 3554C L	396	396	899	899	326	326	326	326	356	356	356	356	366	366	366	366	39'	39'	1264'	8	8	8	8	
LSK 3554C VL	396	396	1049	1049	326	326	326	326	356	356	356	356	366	366	366	366	39'	39'	1414'	8	8	8	8	

1. The forward dimensions (D.E.) are established at the level of the shaft shoulder.

Type	Main dimensions															
	N1	N2	Q1	U1	U2	u1	u2	V1	V2	v1	v2	W1	W2	X1	Y1	Y2
LSK 2504C M	300	300	730	180	190	292	240	320	260	56	25	280	280	44	6	6
LSK 2504C L	300	300	790	180	190	292	240	320	260	56	25	280	280	44	6	6
LSK 2804C SM	350	350	895	187	187	247	247	277	277	30	30	320	320	50	8	8
LSK 2804C M	350	350	860	289	187	349	247	380	277	30	30	320	320	50	8	8
LSK 2804C SL	350	350	1005	187	187	247	247	277	277	30	30	320	320	50	8	8
LSK 2804C L	350	350	970	289	187	349	247	380	277	30	30	320	320	50	8	8

# Open continuous current (DC) motors LSK

## Dimensions

### Dimensions of the options for open continuous current (dc) motors LSK

Dimensions in millimetres

#### Dimensions of the (FF) plain holes flange adaptor

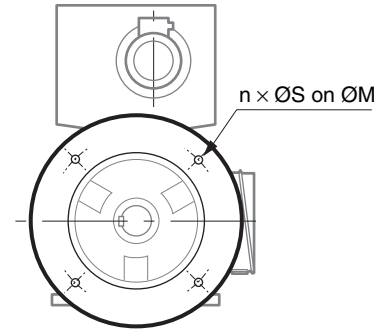
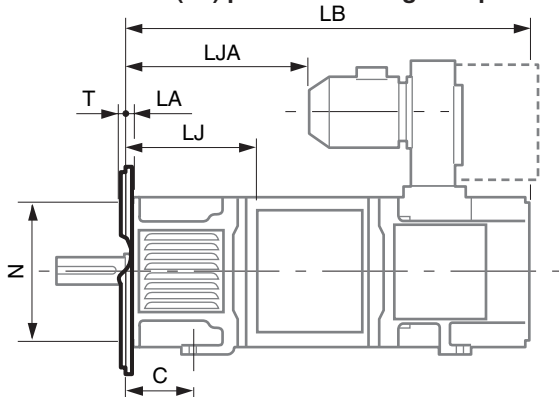

LSK motor Size	IEC symbol	Flange dimensions					
		LA	M	N	n	S	T
1124	FF 215	55	215	180	4	14	4
1324	FF 215	54	215	180	4	14	4
1324	FF 400	54	400	350	4	14	4
1604	FF 265	64	265	230	4	14	4
1604	FF 300	64	300	250	4	18	5

LSK motor Size	Flange dimensions			
	C	LB	LJ	LJA
1124 M	95	571	208	224
1124 L	95	641	278	294
1124 VL	95	711	348	364
1324 S	121	622	197	237
1324 M	121	672	247	287
1324 VL	121	772	347	387
1324 XVL	121	842	417	457
1604 S	143	790	311	333
1604 M	143	870	391	413
1604 L	143	930	451	473
1604 VL	143	1030	551	573

#### Brake dimensions

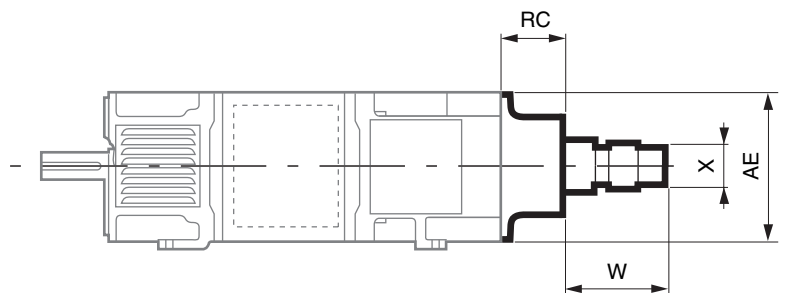

LSK motor Size	Type 458			
	AE	RC	X(1)	W(1)
1124	215	88	*	R-36
1324	254	100	*	R-34
1604	305	127	*	R-44
1804-1804C	-	-	-	-
2004	-	-	-	-
2254	-	-	-	-
2504C	-	-	-	-
2804C	-	-	-	-
3554C	-	-	-	-

# Open continuous current (DC) motors LSK

## Dimensions

### Dimensions of the options for open continuous current (dc) motors LSK

Dimensions in millimetres

#### Tachometric dynamo

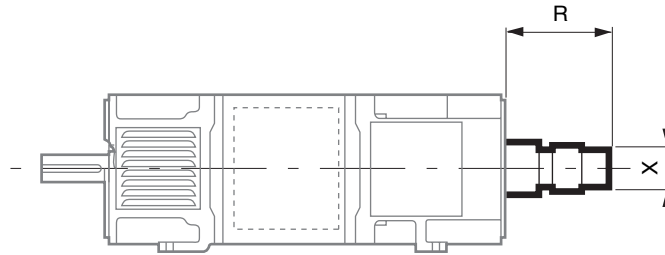

Motor LSK Size	REO 444				REO 444R				REO 444 L1		RDC 15	
	1 commutator		2 commutators		1 commutator		2 commutators		1 commutator		1 commutator	
	R	X	R	X	R	X	R	X	R	X	R	X
1124	192	75	208	75	200	94	219	94	135.5	88	66	98
1324	192	75	208	75	200	94	219	94	135.5	88	66	98
1604	192	75	208	75	200	94	219	94	135.5	88	66	98
1804	180	75	196	75	188	94	207	94	123.5	88	75	98
2004	180	75	196	75	188	94	207	94	123.5	88	71	98
2254	180	75	196	75	188	94	207	94	123.5	88	71	98
2504C	182	75	198	75	190	94	209	94	125.5	88	71	98
2804C	182	75	198	75	190	94	209	94	125.5	88	71	98
3554C	185	75	201	75	190	94	209	94				

#### GHM5 10 59 6R pulse generator

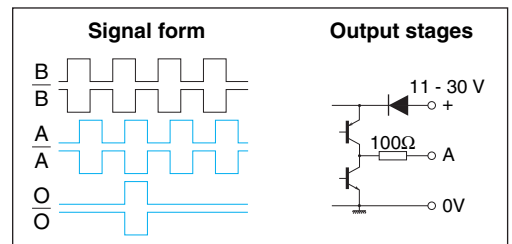
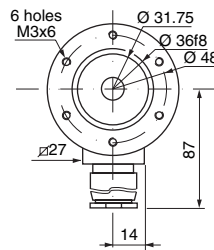
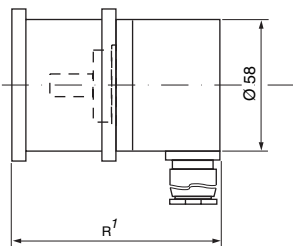

#### Tachometric dynamo + Encoder

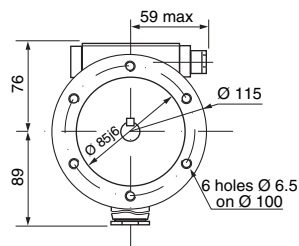
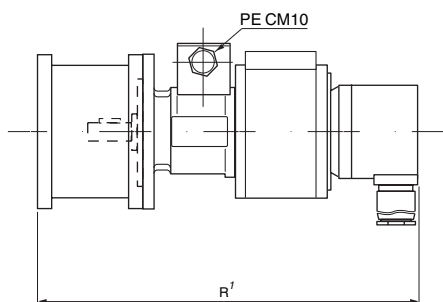

#### Shaft end detail

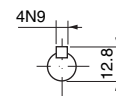

1. LSK 1124 to 1604 : R = 113.5 ; LSK 1804 : R = 101.5

